

# MATERIAL HANDLING PRODUCTIVITY SOLUTIONS

STORE : ORGANIZE : TRANSPORT

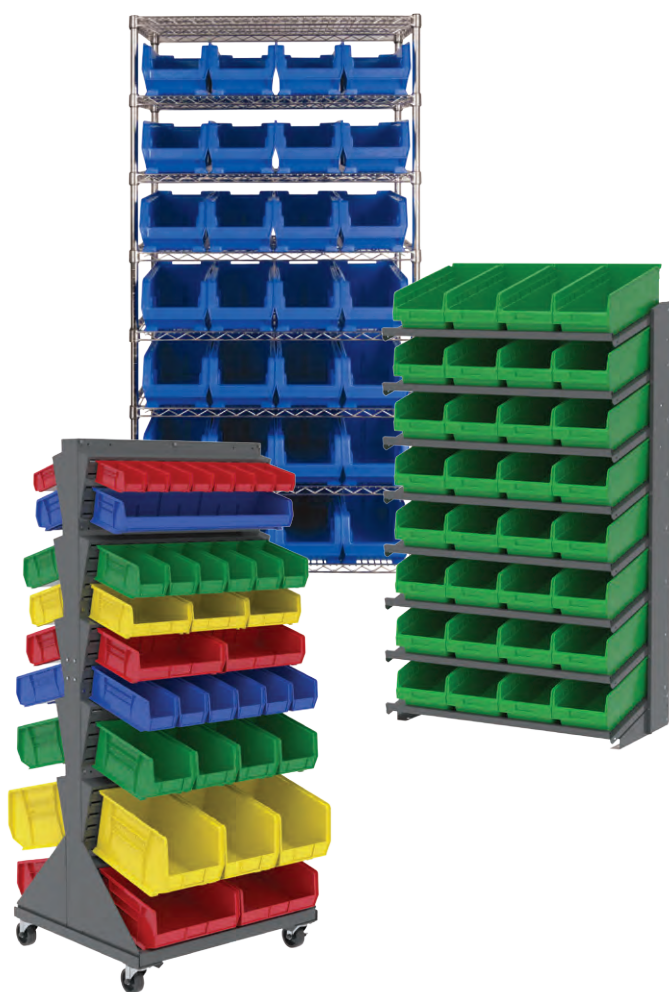

2013

## INNOVATIVE NEW PRODUCTS

INSIGHT™ BINS . . . . .	9
LEAN PANEL™ . . . . .	30
INDICATOR™ BINS . . . . .	15
18 INCH DEEP PICK RACKS . . . . .	35
LOW-PROFILE LOUVERED FLOOR RACK . . . . .	29



## CLEAR BINS, TOTES & CONTAINERS

Akro-Mils now provides the largest selection of clear storage solutions in the industry: new Shelf Bins, ShelfMax® Bins, Akro-Grids and Super-Size AkroBins® join our existing selection of clear products, which includes AkroBins®, AkroDrawers®, InSight® Bins, and Stak-N-Store Bins.

In addition to the new clear option, Akro-Mils' industry-leading bins and containers are available in a variety of colors that are ideal for use in any environment to simplify organization, improve handling efficiency and maximize floor space. Akro-Mils products are a durable and cost-effective solution for creating a clean, safe and efficient work environment.

Akro-Mils' new clear bins and containers are available in a variety of complete packages such as wire shelving, steel shelving, pick racks and louvered panels.

Just look for  to locate clear bins and containers.



**CLEAR**  
STORAGE SOLUTIONS

## AKRO-MILS & THE 5S LEAN PROCESS

Converting your workplace to 5S Lean with innovative products from Akro-Mils is good business!

Organizations that invest in a 5S Lean process – a methodology to improve efficiencies and enhance operational excellence – gain productivity, create higher quality products and lower operating costs by simply implementing a system of waste removal, visual identification and efficient use of space.

Whether choosing bins, containers or carts from our extensive selection, or creating a custom system, Akro-Mils' products and services add value at every stage of your 5S operation – improving your productivity and performance!

Go to [akro-mils.com/Resources/5S-Lean.aspx](http://akro-mils.com/Resources/5S-Lean.aspx) and just click the Quick Link to order your kit today or to access more 5S resources. Scan the QR Code to view our 5S video.



LEAN



The Akro-Mils 5S Kit

# TABLE OF CONTENTS



## Storage Bins – Hanging & Stacking..... 04-11

- |                                   |                         |
|-----------------------------------|-------------------------|
| 04 AkroBins                       | 09 InSight              |
| 05 ProHanger, Slope-It, Bin Clip  | 10 Stak-N-Store         |
| 06 Super-Size AkroBins            | 11 Labels, Card Holders |
| 08 EarthSaver AkroBins, 1800, ESD |                         |

## Storage Bins – Shelf Style..... 12-17

- |                              |                |
|------------------------------|----------------|
| 12 Shelf Bins                | 15 Indicator   |
| 13 ShelfMax Bins             | 16 System Bin  |
| 14 EarthSaver Shelf Bins     | 17 AkroDrawers |
| 14 VantageBins, Economy Bins |                |

## Heavy-Duty Totes & Containers..... 18-25

- |                                     |                                   |
|-------------------------------------|-----------------------------------|
| 18 Nest & Stack Totes (NST)         | 23 Straight Wall Containers (SWC) |
| 20 Akro-Grid                        | 24 Akro-Tub, Cross-Stack Akro-Tub |
| 22 Attached Lid Containers, KeepBox | 25 Gravity Hopper                 |

## Small Parts Storage..... 26-27

- |                     |                           |
|---------------------|---------------------------|
| 26 Storage Cases    | 27 Portable Organizer     |
| 26 ProBox Toolboxes | 27 Roto-Shelf, Tote Caddy |

## Bin Hanging Systems & Racks..... 28-35

- |                    |                         |
|--------------------|-------------------------|
| 28 Louvered Panels | 32 Rail Hanging Systems |
| 30 Lean Panel      | 33 Pick Racks           |
| 31 ReadySpace      | 34 Pick Rack Systems    |

## Cabinets..... 36-45

- |                            |                                 |
|----------------------------|---------------------------------|
| 36 TiltView                | 42 RTA, Heavy-Duty Bin Cabinets |
| 38 19 & 17 Series Cabinets | 43 Secure Mini-Cabinets         |
| 40 Plastic Cabinets        | 44 Stackable Cabinets           |
| 41 Standard Bin Cabinets   | 45 Super Modular Cabinets       |

## Shelving Systems..... 46-51

- |                          |                           |
|--------------------------|---------------------------|
| 46 Wire Shelving Systems | 49 Steel Shelving Systems |
|--------------------------|---------------------------|

## Platform Trucks..... 52-57

- |                           |                                      |
|---------------------------|--------------------------------------|
| 52 VERSA/Deck             | 55 Platform Trucks, Super Heavy-Duty |
| 54 Platform Trucks, Wood  | 56 Platform Trucks, Work Height      |
| 55 Platform Trucks, Steel | 57 Semi-Live Skids                   |

## Carts & Work Centers..... 58-63

- |                                  |  |
|----------------------------------|--|
| 58 ProCart                       | 61 Super-Size AkroBin Carts                    |
| 59 Louvered Cart                 | 62 Portable Tables & Carts, Mobile Work Tables |
| 60 Shelf Carts                   | 63 Heavy-Duty Work Benches                     |
| 61 Box Carts, Tray Service Carts |  |

## Dollies..... 64-67

- |                    |                               |
|--------------------|-------------------------------|
| 64 Wood Dollies    | 66 Steel Dollies              |
| 65 Plastic Dollies | 67 Bin-Specific Steel Dollies |

## Hand Trucks..... 68-69

- |                                       |               |
|---------------------------------------|---------------|
| 68 Heavy-Duty, Medium-Duty, Specialty | 69 Pail Truck |
| 69 Dual-Purpose Hand Truck            |               |

## Bulk Handling..... 70

- |                                 |
|---------------------------------|
| 70 Akro-Tilt Trucks, Akro-Carts |
|---------------------------------|

## Caster Descriptions..... 71

## Custom & OEM Capabilities..... 72-73

## Index..... 74-75





# AkroBins®

## INDUSTRY-LEADING HANGING & STACKING BINS



MADE IN THE USA

### FEATURES

- 1 Anti-slide stop prevents stacked bins from shifting forward
- 2 Optional dividers allow you to create customizable compartment sizes
- 3 Full-width hanger lip supports bin on hanging system
- 4 Curved-bottom hopper front makes it easy to retrieve small parts
- 5 Reinforced side ribs add strength and prevent spreading when stacked
- 6 Large front label area for easy coding and scanning
- 7 Extra-wide stacking ledge provides stability, saves space and prevents spills

### PRODUCT HIGHLIGHTS

- **EFFICIENT** – Control inventories, shorten assembly times, minimize parts handling
- **FUNCTIONAL** – Heavy-duty bins securely stack atop each other, sit on shelving, and hang from Akro-Mils racks, panels, rails and carts
- **DURABLE** – Molded of industrial-grade polymers, AkroBins are resistant to weak acids and alkalis. Water, rust and corrosion-proof
- **VARIETY** – Available in 14 sizes and 7 Standard Colors: Red, Blue, Yellow, Stone, Green, Black and Clear! 4 Specialty Colors: Berry, Light Blue, Purple, Teal available in 9 sizes
- **GUARANTEED** – AkroBins are guaranteed not to crack or break under normal load conditions as stated in our 1-year limited warranty



#### STANDARD COLORS

Red, Yellow, Blue, Stone, Green, Clear, Black



#### SPECIALTY COLORS

Berry, Light Blue, Purple, Teal



Also available in recycled Hunter Green, Sandstone and Terra Cotta. See Pg. 8.





800.253.2467  
akro-mils.com

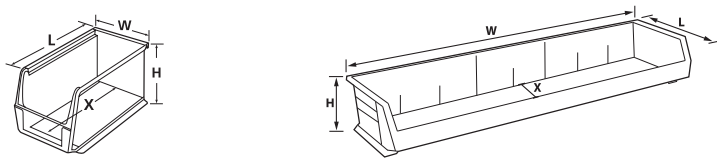

AkroBins Model No.	Outside Dimensions (In.)			Bottom Dimensions (In.)				Capacity/Quantity		Accessories							
	L	W	H	L	W	H	X	Bin Load Capacity On Rack	Bin Ctn. Qty.	Length Dividers**	Width Dividers**	Divider Pkg. Qty.	Bin Lids***	Lid Pkg. Qty.	Adhesive Labels	Card Stock	Slope-It Bin Inserts
30210*	5 $\frac{3}{8}$	4 $\frac{3}{8}$	3	4 $\frac{3}{8}$	3 $\frac{1}{8}$	2 $\frac{3}{8}$	4	10 lbs.	24	40210 (1)	-	6	30211CRY	24	29202	29301	-
30220*	7 $\frac{3}{8}$	4 $\frac{3}{8}$	3	6 $\frac{3}{8}$	3 $\frac{1}{8}$	2 $\frac{3}{8}$	6	10 lbs.	24	40220 (1)	-	6	30221CRY	24	29202	29301	-
30224*	10 $\frac{7}{8}$	4 $\frac{3}{8}$	4	10 $\frac{1}{4}$	3 $\frac{3}{8}$	3 $\frac{3}{4}$	9	30 lbs.	12	40224 (1)	-	-	30225CRY	12	29202	29301	46224
30230*	10 $\frac{7}{8}$	5 $\frac{1}{2}$	5	10 $\frac{1}{4}$	4 $\frac{3}{8}$	4 $\frac{3}{4}$	9	30 lbs.	12	40230 (1)	41230 (3)	6	30231CRY	12	29203	29302	46230
30234*	14 $\frac{3}{4}$	5 $\frac{1}{2}$	5	14 $\frac{1}{8}$	4 $\frac{3}{8}$	4 $\frac{3}{4}$	12 $\frac{3}{8}$	50 lbs.	12	40234 (1)	-	-	-	-	29203	29302	-
30239*	10 $\frac{3}{4}$	8 $\frac{3}{4}$	7	10	6 $\frac{3}{8}$	6 $\frac{3}{4}$	8	50 lbs.	6	40239 (1)	-	6	-	-	29203	29302	-
30240*	14 $\frac{3}{4}$	8 $\frac{3}{4}$	7	14	6 $\frac{3}{8}$	6 $\frac{3}{4}$	12	60 lbs.	12	40245 (1)	-	6	-	-	29203	29302	46240
30265	18	8 $\frac{3}{4}$	9	17 $\frac{7}{8}$	6 $\frac{3}{4}$	8 $\frac{3}{4}$	14 $\frac{1}{2}$	60 lbs.	6	40265 (1)	-	6	-	-	29203	29303	-
30235*	10 $\frac{7}{8}$	11	5	10 $\frac{1}{4}$	10	4 $\frac{3}{4}$	9	50 lbs.	6	40230 (3)	-	6	30236CRY	6	29203	29302	-
30260	18	11	10	17	9 $\frac{1}{2}$	9 $\frac{3}{4}$	14 $\frac{3}{8}$	60 lbs.	6	40260 (3)	-	6	-	-	29203	29303	-
30255	10 $\frac{7}{8}$	16 $\frac{1}{2}$	5	9 $\frac{3}{4}$	15	4 $\frac{3}{4}$	9	60 lbs.	6	40230 (3)	-	6	-	-	29203	29302	-
30250*	14 $\frac{3}{4}$	16 $\frac{1}{2}$	7	14	14 $\frac{3}{4}$	6 $\frac{3}{4}$	12	75 lbs.	6	40245 (3)	41250 (6)	6	-	-	29203	29302	-
30270	18	16 $\frac{1}{2}$	11	17 $\frac{7}{8}$	14 $\frac{3}{4}$	10 $\frac{1}{4}$	14	75 lbs.	3	40270 (3)	41270 (6)	6	-	-	29203	29303	-
30320	8 $\frac{5}{8}$	33	5	7	31 $\frac{1}{2}$	4 $\frac{3}{8}$	6	80 lbs.	4	40321 & 40220 (7)	-	7	30321	4	-	-	-

One color per carton: Specify Red, Blue, Yellow, Stone, Clear, Green or Black. Order in carton quantities. CAUTION: When using bins with hanging systems, do not exceed the weight capacity for the rack, which may be less than the total sum of bin capacities. 40321= Tall Divider; 40220=Short Divider. \*Available in Specialty Colors: Berry, Purple, Teal and Light Blue. \*\*(\*)=Max. # of dividers per bin. \*\*\*Assembly required - 30211CRY replaces 30211; 30221CRY replaces 30221; 30231CRY replaces 30231; 30236CRY replaces 30236.

**ProHANGER**

Model No.	L	W	H	Bin Load Capacity On Rack	Bin Ctn. Qty.	End Cap Divider (6 Pk)	End Cap Divider (2 Pk)
30330RED	7 $\frac{3}{4}$	8 $\frac{3}{4}$	5	75 lbs.	6	40330	403302PK

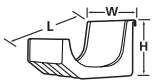

**ACCESSORIES**



**See Through Crystal Clear Lids**  
Keep contents dust-free and protected  
**NEW! STYLE**



**Adhesive Labels & Card Stock Holders**  
Clearly identify bin contents. See Pg. 11



**Length Dividers**  
Keep items separated in bin. Now available for all sizes!



**Slope-It™ Bin Inserts**  
15° slope inserts for 30224, 30230 and 30240 AkroBins improve visibility and accessibility of supplies by keeping them close to the front of the bin. Transform your AkroBins in one easy step!  
**NEW!**



**Width Dividers**  
Available for 30230, 30250 and 30270



**Bin Retainer Clip**  
**Model No. 40599**  
Hold bins securely on louvered panels. Will work with any size AkroBin or ProHANGER. Perfect for service vans and maintenance workers, plumbers, electricians or other tradesmen who store and transport supplies and materials

**ProHANGER**



**Model No. 30330RED**  
Can be placed side-by-side on walls, rail rack or panel systems to store extra-long parts or supplies

- Unique J-Hook design cradles various shapes and sizes of contents
- Available End Cap inserts (sold separately) keep items from sliding out
- Each ProHANGER is capable of supporting up to 75 lbs.

**RELATED PRODUCTS**  
Create the perfect storage system - mix and match your selection of AkroBins with compatible products



**28-29** Louvered Hanging Systems



**31** ReadySpace Storage Systems



**32** Rail Hanging Systems



**41-42** Bin Cabinets



**46-48** Wire Shelving Systems



**58** ProCart



# Super-Size AkroBins®

INDUSTRY-LEADING LARGE-CAPACITY STACKING BINS



## FEATURES

- 1 Anti-slide stop prevents stacked bins from shifting forward
- 2 Easy to carry with large handle molded onto back of bin
- 3 Reinforced side ribs add strength and prevent spreading when stacked
- 4 Large label area on front of bin
- 5 Divider slots help create separate compartments

## PRODUCT HIGHLIGHTS

- **CAPACITY** – Large-capacity storage to improve organization and workflow
- **STACKABLE** – Heavy-duty bins securely stack atop each other, sit on shelving, carts or dollies
- **DURABLE** – Molded of industrial-grade polymers, Super-Size AkroBins are resistant to weak acids and alkalis. Water, rust and corrosion-proof
- **VARIETY** – Available in 12 sizes and 4 colors: Red, Blue, Yellow, Clear
- **GUARANTEED** – Super-Size AkroBins are guaranteed not to crack or break under normal load conditions as stated in our 1-year limited warranty



30280

30281



30282

30283

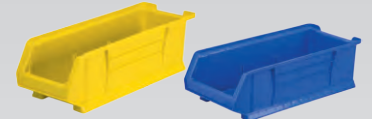

30284

30286



30287

30288



30289



30290



30292



30293

## COLORS

Red, Yellow, Blue, Clear



800.253.2467  
akro-mils.com

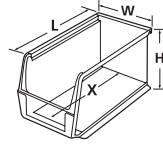

Super-Size AkroBins Model No.	Outside Dimensions (In.)			Inside Dimensions (In.)				Capacity/Quantity			Accessories						
	L	W	H	L	W	H	X	Max. Cap. per Bin	Stacking Cap./= Qty. Stacked	Ctn. Qty.	Width Dividers*	Length Dividers*	Divider Pkg. Qty. W L	Windows	Window Pkg. Qty.	Card Stock Holder	
30280	20	12 <sup>3</sup> / <sub>8</sub>	6	16 <sup>7</sup> / <sub>8</sub>	10 <sup>1</sup> / <sub>8</sub>	5 <sup>3</sup> / <sub>8</sub>	15 <sup>1</sup> / <sub>2</sub>	200 lbs.	40 lb./10	4	-	40280 (3)	-	2	21280	2	29304
30281	20	12 <sup>3</sup> / <sub>8</sub>	8	16 <sup>7</sup> / <sub>8</sub>	10 <sup>1</sup> / <sub>8</sub>	7 <sup>3</sup> / <sub>8</sub>	15 <sup>1</sup> / <sub>2</sub>	200 lbs.	50 lb./7	3	-	40281 (3)	-	3	21281	3	29304
30282	20	12 <sup>3</sup> / <sub>8</sub>	12	16 <sup>7</sup> / <sub>8</sub>	10 <sup>1</sup> / <sub>8</sub>	11 <sup>3</sup> / <sub>8</sub>	15 <sup>1</sup> / <sub>2</sub>	200 lbs.	60 lb./5	2	-	40282 (3)	-	1	21282	2	29304
30283	20	18 <sup>3</sup> / <sub>8</sub>	12	16 <sup>7</sup> / <sub>8</sub>	16 <sup>3</sup> / <sub>8</sub>	11 <sup>3</sup> / <sub>8</sub>	15 <sup>1</sup> / <sub>2</sub>	300 lbs.	150 lb./5	1	-	40282 (3)	-	1	21283	1	29304
30284	23 <sup>3</sup> / <sub>8</sub>	8 <sup>1</sup> / <sub>4</sub>	7	20 <sup>3</sup> / <sub>8</sub>	6 <sup>3</sup> / <sub>8</sub>	6 <sup>1</sup> / <sub>8</sub>	19 <sup>3</sup> / <sub>8</sub>	200 lbs.	150 lb./5	4	41284 (2)	40286 (1)	2	4	21284	4	29304
30286	23 <sup>3</sup> / <sub>8</sub>	11	7	20 <sup>3</sup> / <sub>8</sub>	9 <sup>3</sup> / <sub>8</sub>	6 <sup>1</sup> / <sub>8</sub>	19 <sup>3</sup> / <sub>8</sub>	200 lbs.	150 lb./5	4	41286 (2)	40286 (3)	2	4	21286	4	29304
30287	23 <sup>3</sup> / <sub>8</sub>	11	10	20 <sup>3</sup> / <sub>8</sub>	9	9 <sup>1</sup> / <sub>8</sub>	19 <sup>3</sup> / <sub>8</sub>	300 lbs.	150 lb./5	4	41287 (2)	40287 (3)	6	6	21287	4	29304
30288	23 <sup>3</sup> / <sub>8</sub>	16 <sup>1</sup> / <sub>2</sub>	11	20 <sup>3</sup> / <sub>8</sub>	14 <sup>3</sup> / <sub>8</sub>	10 <sup>1</sup> / <sub>8</sub>	19 <sup>3</sup> / <sub>8</sub>	300 lbs.	150 lb./5	1	41288 (2)	40287 (3)	6	6	21288	1	29304
30289	23 <sup>3</sup> / <sub>8</sub>	18 <sup>3</sup> / <sub>8</sub>	12	20 <sup>3</sup> / <sub>8</sub>	16	11 <sup>3</sup> / <sub>8</sub>	19 <sup>3</sup> / <sub>8</sub>	300 lbs.	150 lb./5	1	41289 (2)	40289 (3)	2	1	21289	1	29304
30290	29 <sup>1</sup> / <sub>8</sub>	18 <sup>3</sup> / <sub>8</sub>	12	26 <sup>1</sup> / <sub>8</sub>	16 <sup>3</sup> / <sub>8</sub>	11 <sup>3</sup> / <sub>8</sub>	24 <sup>3</sup> / <sub>8</sub>	300 lbs.	150 lb./5	1	-	40290 (3)	-	1	21283	1	29304
30292	29 <sup>1</sup> / <sub>8</sub>	11	10	26 <sup>3</sup> / <sub>8</sub>	9	9 <sup>1</sup> / <sub>8</sub>	25 <sup>3</sup> / <sub>8</sub>	300 lbs.	150 lb./5	4	41287 (2)	40292 (3)	6	6	21287	4	29304
30293	29 <sup>1</sup> / <sub>8</sub>	16 <sup>1</sup> / <sub>2</sub>	11	26 <sup>3</sup> / <sub>8</sub>	14 <sup>3</sup> / <sub>8</sub>	10 <sup>1</sup> / <sub>8</sub>	25 <sup>3</sup> / <sub>8</sub>	300 lbs.	150 lb./5	1	41288 (2)	40292 (3)	6	6	21288	1	29304

One color per carton: Specify Red, Blue, Yellow or Clear. Not recommended to hang on rack or panel systems. Order in carton quantities. \* ( ) = Max. # of divider slots per bin.

## ACCESSORIES



**Window Insert**  
Optimizes interior space and keeps contents visible



**Width Dividers**  
Available for 7 bin models



**Length Dividers**  
Available for all sizes



**Adhesive Labels & Card Stock Holders**  
Card Stock Holders fit in bins' existing slot; adhesive labels also available. See Pg. 11

## SUPER-SIZE AKROBIN® CARTS



Easy organization of bulky parts in 4, 6, 9, 12 and 16-bin configurations

- Carts hold a variety of Super-Size AkroBins (sold separately)
- Heavy-duty frames with capacity from 900 to 1,500 lbs. (See Pg. 61)

**RELATED PRODUCTS**  
Increase the benefits of your Super-Size AkroBins with the following products



46-48 Wire Shelving Systems



49-51 Steel Shelving Systems



61 Super-Size Bin Carts



67 Dollies



# Specialty AkroBins®

EARTHSAVER AKROBINS: 1800 SERIES AKROBINS : ESD CONTAINERS

## EarthSaver® Series: AkroBins®

AKROBINS MADE OF RECYCLED MATERIAL



MADE IN THE USA

- **RECYCLED** – EarthSaver AkroBins made of 100% recycled material. Make a positive impact on the environment!
- **GUARANTEED** – EarthSaver AkroBins are guaranteed not to crack or break under normal load conditions as stated in our 1-year limited warranty
- **VARIETY** – Available in 7 sizes and 3 colors: Hunter Green, Sandstone and Terra Cotta
- **ACCESSORIES** – Crystal Clear Lids, Length Dividers and Width Dividers available (see Pg. 5)

### COLORS

Hunter Green, Sandstone, Terra Cotta

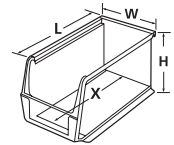

EarthSaver AkroBins Model No.	Outside Dimensions (In.)			Inside Dimensions (In.)				Capacity/Quantity	
	L	W	H	L	W	H	X	Bin Load Capacity On Rack	Bin Ctn. Qty.
30210RECY	5%	4%	3	4%	3 <sup>3</sup> / <sub>16</sub>	2 <sup>3</sup> / <sub>16</sub>	4	10 lbs.	24
30220RECY	7%	4%	3	6%	3 <sup>3</sup> / <sub>16</sub>	2 <sup>3</sup> / <sub>16</sub>	6	10 lbs.	24
30230RECY	10%	5 <sup>1</sup> / <sub>2</sub>	5	10%	4%	4%	9	30 lbs.	12
30234RECY	14%	5 <sup>1</sup> / <sub>2</sub>	5	14%	4%	4%	12 <sup>3</sup> / <sub>16</sub>	50 lbs.	12
30239RECY	10%	8%	7	10	6%	6%	8	50 lbs.	6
30240RECY	14%	8%	7	14	6%	6%	12	60 lbs.	12
30250RECY	14%	16 <sup>1</sup> / <sub>2</sub>	7	14	14%	6%	12	75 lbs.	6

One color per carton: SS = Sandstone, TC = Terra Cotta and HG = Hunter Green. Order in carton quantities. CAUTION: When using bins with hanging systems, do not exceed the weight capacity for the rack, which may be less than the total sum of bin capacities.

## 1800 Series AkroBins®

STACKABLE SHELF BINS



MADE IN THE USA

### COLOR

Beige

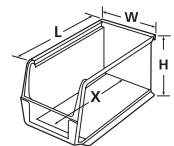

1800 Series Model No.	Outside Dimensions (In.)			Inside Dimensions (In.)				Ctn. Qty.	Dividers	Pkg. Qty.	Capacity (Lbs.)
	L	W	H	L	W	H	X				
30348BEIGE	20 <sup>1</sup> / <sub>2</sub>	8%	7	20	7%	6 <sup>1</sup> / <sub>2</sub>	20	6	40348 (3)	6	60
30358BEIGE	20 <sup>1</sup> / <sub>2</sub>	11	7	20	10%	6 <sup>1</sup> / <sub>2</sub>	20	6	40358 (3)	6	75

Available in Beige. Order in carton quantities.

- **DURABLE** – Strong industrial-grade polymer construction
- **STACKING** – Stackable storage systems for large, heavy or bulky items
- **DIVIDABLE** – One black width divider included per bin

## ESD Containers

AKROBINS MADE WITH ELECTROSTATIC DISSIPATIVE MATERIALS



MADE IN THE USA

- **PROTECTION** – Dissipate electrostatic charges, which can severely damage sensitive electronic components
- **OHM RATING** – Static Dissipative Range 10<sup>6</sup> to 10<sup>9</sup> ohms/sq.
- **LOW CARBON** – 1% - 2% carbon content

### COLOR

Black

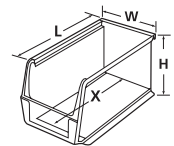

ESD Containers Model No.	Inside Dimensions (In.)			Outside Dimensions (In.)				Cap. on Rack	Ctn. Qty.
	L	W	H	L	W	H	X		
30210ESD	5%	4%	3	4%	3 <sup>3</sup> / <sub>16</sub>	2 <sup>3</sup> / <sub>16</sub>	4	10 lbs.	24
30220ESD	7%	4%	3	6%	3 <sup>3</sup> / <sub>16</sub>	2 <sup>3</sup> / <sub>16</sub>	6	10 lbs.	24
30230ESD	10%	5 <sup>1</sup> / <sub>2</sub>	5	10%	4%	4%	9	30 lbs.	12
30235ESD	10%	11	5	10%	10	4%	9	50 lbs.	6
30240ESD	14%	8%	7	14	6%	6%	12	60 lbs.	12

Available in Black. Order in carton quantities.



# InSight®

## ULTRA-CLEAR POLYCARBONATE BINS

800.253.2467  
akro-mils.com



STORAGE BINS –  
HANGING & STACKING

### FEATURES

- 1 Unique "lock-in-place" design for secure stacking
- 2 Strong molded hanger supports bins on hanging systems
- 3 Large label area for part identification and bar code scanning
- 4 Optional lids (sold separately) protect contents from dust. Will stack with lids in place!
- 5 Clear length and width dividers available (sold separately)



MADE IN THE USA



305A1

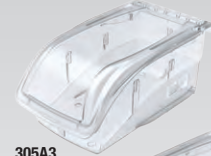

305A3

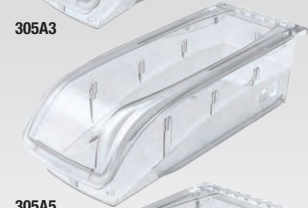

305A5

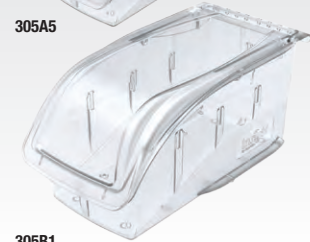

305B1

### PRODUCT HIGHLIGHTS

- **VISIBILITY** – Bins provide easy and maximum visibility of parts and supplies
- **FUNCTIONAL** – Bins securely stack, and hang from louvered panels, rails and the ReadySpace® Storage System
- **NO-TIP FEATURE** – Patent-pending design: Bins won't tip when stacked!
- **DURABLE** – Products made of high-impact polycarbonate are autoclavable up to 350° F
- **VARIETY** – Available in 4 sizes

COLOR  
Clear



insight  
by Akro-Mils

InSight Model No.	Outside Dimensions (In.)			Inside Dimensions (In.)			Capacity/Quantity		Accessories					
	L	W	H	L	W	H	Capacity (lbs.)	Bin Ctn. Qty.	Width Divider	Divider Pkg Qty.	Length Divider	Divider Pkg Qty.	Lid	Lid Pkg Qty.
305A1	5%	4%	3%	4%	3%	2%	10	16	415A1 (1)	8	405A1 (1)	8	305A2	16
305A3	7%	4%	3%	6%	3%	2%	10	16	415A1 (2)	8	405A3 (1)	8	305A4	16
305A5	10%	4%	3%	9%	3%	2%	15	12	415A1 (3)	8	405A5 (1)	6	305A6	12
305B1	10%	5½	5%	9%	4%	4%	25	12	415B1 (3)	6	405B1 (1)	6	305B2	12

# in ( ) represents divider slots per bin.

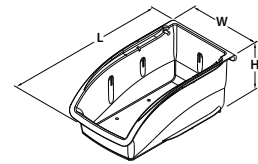

### ACCESSORIES



**Lids**  
Protect bin contents from dust



**Dividers**  
Expand sorting options with length dividers

### RELATED PRODUCTS

Create the perfect storage solution — mix and match your InSight Bins with these products



28-30 Louvered Hanging Systems



31 ReadySpace Storage Systems



32 Rail Hanging Systems



# Stak-N-Store Bins

STACKABLE BINS PERFECT FOR HEAVY, BULKY ITEMS



MADE IN THE USA



## COLORS

Red, Blue, White, Clear, Gray



## FEATURES

- 1 Large radius corners and rolled rim add strength
- 2 Side ribs add stability when stacked
- 3 Wide hopper front allows easy access to bulky items
- 4 Large comfort grip handles

## PRODUCT HIGHLIGHTS

- **STACKBLE** – Bins stack to form tall, stable storage arrangements on floors or standard industrial shelving
- **CAPACITY** – 75-lb. weight capacity
- **DURABLE** – Durable, industrial-grade polymer will not rust, corrode or bend out of shape even when fully loaded
- **COST-EFFECTIVE** – Longer service life resulting in lower replacement costs
- **VARIETY** – Available in 3 sizes and 5 colors: Red, Blue, Gray, White, Clear



Stak-N-Store Bins Model No.	Outside Dimensions (In.)			Inside Dimensions (In.)				Capacity/Quantity				
	L	W	H	L	W	H	X	Cu. Ft.	Gal	Lbs.	Stacking Height	Ctn. Qty.
13014	17½	10¾	12½	15¾	8	12¼	13½	.98	7.4	75	3	4
13017*	15¼	19¾	12¾	13¾	17½	12¼	11½	1.7	12.7	75	3	3
13018	17½	16½	12½	15¾	13¾	12¼	13½	1.6	12	75	3	2

One color per carton. Specify Red, Blue, Gray or Clear. \*13017 also available in White. Order in carton quantities.

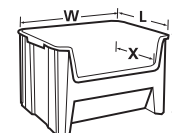

## RELATED PRODUCTS

Add mobility to your Stak-N-Store Bins with



46-48 Wire Shelving Systems



49-51 Steel Shelving Systems



67 Dollies



# Adhesive Labels & Card Holders

2 NEW LABELING OPTIONS FOR AKRO-MILS  
BINS, TOTES, CONTAINERS

800.253.2467  
akro-mils.com



## PRODUCT HIGHLIGHTS

- **FUNCTIONAL** – Can be used on a variety of Akro-Mils bins, totes and containers
- **EFFICIENT** – Perfect for 5S Lean and other productivity initiatives
- **VARIETY** – Card Stock Holders, Adhesive Labels, Adhesive Backed Card Holders available

### Card Stock Holders

- Clear Plastic Card Holder models 29300, 29301, 29302 and 29303 fit in bin's existing card holder slot
- 29304 Card Stock Holder has adhesive back to work with bins and containers without card slots
- Card stock labels identify contents of bin

### Adhesive Labels

- Designed to fit inside card slot areas on Akro-Mils AkroBins®, ShelfMax® Bins and Shelf Bins
- Acrylic adhesive backing forms permanent bond with bins
- Can be used on a wide range of Akro-Mils bins, totes and containers, including AkroDrawers®, Super-Size AkroBins® and Stak-N-Store

### Adhesive Backed Card Holder

- Model 29304 features an adhesive back to work with bins that do not have card holder slots, such as Super-Size AkroBins, 33" Wide AkroBins, Akro-Tubs, NST's, ALC's, SWC's and Stak-N-Store Bins
- 2<sup>3</sup>/<sub>8</sub>" x 3<sup>7</sup>/<sub>8</sub>" surface area required

Adhesive Labels	Dimensions (In.)		Works With:	Labels Per Sheet	Pkg. Qty.	Total Labels
	W	H				
29200	1 <sup>5</sup> / <sub>8</sub>	3 <sup>3</sup> / <sub>4</sub>	30110*	36	10 Sheets	360
29201	2 <sup>5</sup> / <sub>8</sub>	3 <sup>3</sup> / <sub>4</sub>	30120, 30130, 30150, 30170, 30128, 30138, 30158, 30178, 30124, 30164, 30184, 30174*	24	10 Sheets	240
29202	2 <sup>5</sup> / <sub>8</sub>	7 <sup>1</sup> / <sub>2</sub>	30210, 30220, 30224, All ShelfMax Bins*	20	10 Sheets	200
29203	3 <sup>3</sup> / <sub>8</sub>	1 <sup>1</sup> / <sub>2</sub>	30230, 30234, 30235, 30239, 30240, 30250, 30255, 30260, 30265, 30270*	12	10 Sheets	120

The labels were designed to fit inside our card slot area and have an acrylic adhesive backing. The approximate time for permanent bond is 48 – 72 hours. \*Works with multiple sizes of Super-Size AkroBins, Attached Lid Containers, Nest & Stack Totes, Straight Wall Containers, AkroDrawers or Stak-N-Store Bins.

Card Stock Holder	Dimensions (In.)		Works With:	Cards Per Sheet	Sheets Per Pack	Total Cards Per Pack	Total # of Clear Holders
	W	H					
29300	3	1 <sup>3</sup> / <sub>8</sub>	All 4" Shelf Bins**	24	3	72	25
29301	3	1	30210, 30220, 30224, All ShelfMax Bins	20	3	60	25
29302	4	1 <sup>3</sup> / <sub>4</sub>	30230, 30234, 30235, 30239, 30240, 30250, 30255, 30348, 30358	12	3	36	25
29303	4	2	30260, 30265, 30270, 33223	12	3	36	25
29304*	3 <sup>1</sup> / <sub>2</sub>	2	All Super-Size Akro-Bins, and items without Card Slots – adhesive strip on back	10	3	30	25

The clear holders for the 29300 - 29303 fit in our card slot holder. \*The 29304 has an adhesive back and will work with multiple sizes of products that do not have a card slot holder such as Super-Size AkroBins, 33" Wide AkroBins, Attached Lid Containers, Nest & Stack Totes, Straight Wall Containers or Stak-N-Store Bins. \*\*Excluding 30110 (29300 can be cut to length) 11%.



30230 with 20203



30240 with 20303



30292 with 29304

## 10° EXTENDED LABEL HOLDER



### Model No. 40410

Designed for larger bar code scanning.  
Works with Shelf Bins & ShelfMax

10° Extended Label Holder	Outside Dimensions (In.)			Ctn. Qty.	
	Model No.	L	W		H
	40410	–	4	2 <sup>1</sup> / <sub>4</sub>	24

## RELATED PRODUCTS

Adhesive Labels and Card Holders work with



4-5 AkroBins



6-7 Super-Size AkroBins



12 Shelf Bins



13 ShelfMax



# Shelf Bins

INDUSTRY-LEADING 4" HIGH SHELF BINS ARE DURABLE, EFFICIENT

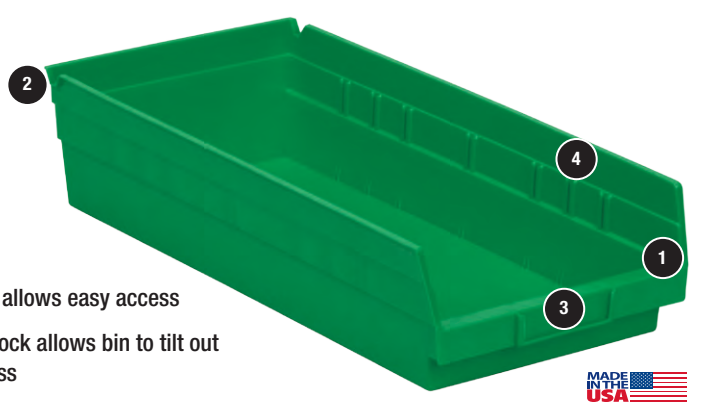

## FEATURES

- 1 Wide hopper front allows easy access
- 2 Built-in rear hanglock allows bin to tilt out for complete access
- 3 Molded-in label area identifies contents
- 4 Each bin accepts up to 7 dividers (except 30110)

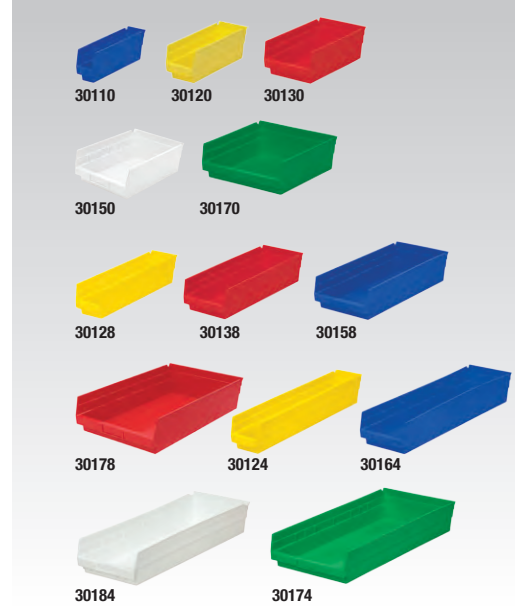

## COLORS

Red, Yellow, Blue, Green, White, Clear



Also available in recycled Hunter Green, Sandstone and Terra Cotta. See Pg. 14.

## PRODUCT HIGHLIGHTS

- **EFFICIENT** – Shelf Bins work with 12", 18" and 24" deep shelving, pick racks or vertical storage and retrieval units
- **DURABLE** – Industrial-grade polymer bins outlast corrugated bins — paying for themselves in reduced replacement costs. Bins won't spread or crack when loaded. One-piece construction is waterproof and resistant to grease or oil
- **NESTABLE** – Shelf Bins nest when empty to conserve space
- **VARIETY** – Available in 13 sizes and 6 colors: Red, Blue, Yellow, Green, White and Clear

Shelf Bins Model No.	Outside Dimensions (In.)			Inside Dimensions (In.)			Capacity/Quantity		Cups per Bin		Accessories			
	L	W	H	L	W	H	Cubic Inches	Ctn. Qty.	Small 30101	Large 30102	Width Dividers*	Divider Pkg. Qty.	Labels	Card Stock
30110	11%	2¾	4	10¼	1¾	4	54	24	3	–	–	–	29200	29300**
30120	11%	4%	4	10¼	3	4	78	24	5	2	40120 (7)	24	29201	29300
30130	11%	6%	4	10¼	5½	4	128	12	9	4	40130 (7)	24	29201	29300
30150	11%	8%	4	10¼	7%	4	138	12	11	4	40150 (7)	24	29201	29300
30170	11%	11%	4	10¼	10	4	197	12	15	6	40170 (7)	24	29201	29300
30128	17%	4%	4	16½	3	4	123	12	8	3	40120 (7)	24	29201	29300
30138	17%	6%	4	16½	5½	4	176	12	15	6	40130 (7)	24	29201	29300
30158	17%	8%	4	16½	7%	4	214	12	15	6	40150 (7)	24	29201	29300
30178	17%	11%	4	16½	10	4	292	12	25	12	40170 (7)	24	29201	29300
30124	23%	4%	4	22½	3	4	199	12	11	4	40120 (7)	24	29201	29300
30164	23%	6%	4	22½	5½	4	321	6	21	8	40130 (7)	24	29201	29300
30184	23%	8%	4	22½	7%	4	346	6	25	8	40150 (7)	24	29201	29300
30174	23%	11%	4	22½	10	4	513	6	35	16	40170 (7)	24	29201	29300

One color per carton: Specify Red, Blue, Yellow, Green, White or Clear. Order in carton quantities. \* ( ) = Max. # of dividers per bin. \*\*29300 must be cut to length to fit 30110.

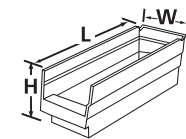

Bin Cups Model No.	Outside Dimensions (In.)			Ctn. Qty.
	L	W	H	
30101	2	3¼	3	48
30102	2¾	5	3	24

## ACCESSORIES



**Dividers**  
Create additional storage compartments (see chart)



**10° Extended Label Holder Model No. 40410**  
Not compatible with 30110. (See Pg. 11)



**Adhesive Labels & Card Stock Holders**  
Card stock holders fit in bins' existing slot; Adhesive labels also available



**Bin Cups**  
Lift out easily for parts retrieval (see chart)



# ShelfMax® Bins

6" HIGH SHELF BINS MAXIMIZE STORAGE CAPACITY

800.253.2467  
akro-mils.com



STORAGE BINS -  
SHELF STYLE

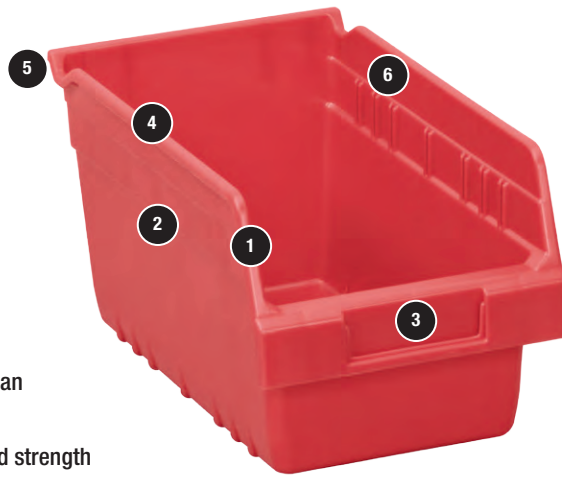

## FEATURES

- 1 Front opening is 3/4" higher than comparable 6" products
- 2 Reinforced side ribs for added strength
- 3 Large label area aids in part identification and bar code scanning
- 4 Rolled ridge provides added strength and durability when filled to capacity
- 5 Built-in rear hanglock allows bin to tilt out for complete access
- 6 Optional dividers create additional storage options

## PRODUCT HIGHLIGHTS

- **CAPACITY** – Bins offer 85% more storage than traditional 4" bins
- **EFFICIENT** – Works with Akro-Mils steel shelving, wire shelving, pick racks and bench racks
- **DURABLE** – Superior construction compared to corrugated bins
- **VARIETY** – Available in 7 sizes and 6 colors: Red, Blue, Yellow, Green, White and Clear



## COLORS

Red, Yellow, Blue, Green, White, Clear



ShelfMax Model No.	Outside Dimensions (In.)			Inside Dimensions (In.)			Capacity/Quantity		Accessories		
	L	W	H	L	W	H	Cubic Inches	Ctn. Qty.	Width Dividers*	Divider Pkg. Qty.	Card Stock
30040	11 1/2	4 1/2	6	9 3/4	2 1/2	5 1/8	175	16	40020 (7)	12	29301
30048	17 1/2	4 1/2	6	16	2 1/2	5 1/8	280	8	40020 (7)	12	29301
30080	11 1/2	8 1/2	6	9 3/4	6 1/2	5 1/8	398	8	40040 (7)	12	29301
30088	17 1/2	8 1/2	6	16	6 1/2	5 1/8	648	8	40040 (7)	12	29301
30090	11 1/2	6 1/2	6	9 3/4	5	5 1/8	310	10	40030 (7)	12	29301
30094	23 1/2	6 1/2	6	21 1/4	5	5 1/8	686	10	40030 (7)	12	29301
30098	17 1/2	6 1/2	6	16	5	5 1/8	505	10	40030 (7)	12	29301

One color per carton. Specify Red, Blue, Yellow, Green, White or Clear. Order in carton quantities. \* ( ) = Max. # of dividers per bin.

## ACCESSORIES



**Dividers**  
Create additional storage compartments



**Adhesive Labels & Card Stock Holders**  
Card stock holders fit in bins' existing slot; Adhesive labels also available. (See Pg. 11)



**10° Extended Label Holder**  
Model No. 40410  
Designed for larger bar code scanning. (See Pg. 11)

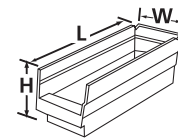

## RELATED PRODUCTS

Create the perfect storage solution — mix and match your ShelfMax Bins with these products



33-35 Pick Rack Systems



46-48 Wire Shelving Systems



49-51 Steel Shelving Systems



# Specialty Shelf Bins

EARTHSAVER SHELF BINS : VANTAGEBINS : ECONOMY BINS

## EarthSaver® Series: Shelf Bins

SHELF BINS MADE OF RECYCLED MATERIAL



- **RECYCLED** – EarthSaver Shelf Bins made of 100% recycled material. Make a positive impact on the environment!
- **VERSATILE** – Optional dividers keep items neatly separated
- **VARIETY** – Available in 8 sizes and 3 colors: Hunter Green, Sandstone and Terra Cotta
- **ACCESSORIES** – Width Dividers and Extended Label Holders available. (See Pg. 12)

### COLORS

Hunter Green, Sandstone, Terra Cotta

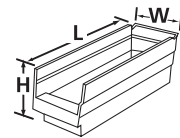

EarthSaver Shelf Bins Model No.	Outside Dimensions (In.)			Inside Dimensions (In.)			Cups per Bin		
	L	W	H	L	W	H	Ctn. Qty.	Small 30101	Large 30102
30110RECY	11½	2¾	4	10¼	1¾	4	24	3	–
30120RECY	11½	4¾	4	10¼	3	4	24	5	2
30130RECY	11½	6¾	4	10¼	5½	4	12	9	4
30150RECY	11½	8¾	4	10¼	7¾	4	12	11	4
30128RECY	17¾	4¾	4	16½	3	4	12	8	3
30138RECY	17¾	6¾	4	16½	5½	4	12	15	6
30124RECY	23¾	4¾	4	22½	3	4	12	11	4
30164RECY	23¾	6¾	4	22½	5½	4	6	21	8

One color per carton: SS = Sandstone, TC = Terra Cotta and HG = Hunter Green. Order in carton quantities.

## VantageBins™

DIVIDABLE UP TO 10 SECTIONS



- **V-GROOVE** – Standard VantageBin has molded-in V-groove bottom to keep items upright and prevent them from sliding
- **NESTABLE** – Both models of VantageBin nest when empty to conserve storage space
- **DURABLE** – Industrial-grade polymer construction
- **VARIETY** – 30420 available in 3 colors: White, Gray, Yellow; 30400 available in 2 colors: White, Gray

### COLORS

White, Gray, Yellow

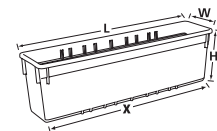

VantageBin		Outside Dimensions (In.)			Inside Dimensions (In.)				Ctn. Qty.	Dividers/Pk.
Model No.	Description	L	W	H	L	W	H	X		
30400YEL10PK	Standard Bin	16¾	7¼	5¾	15½	6¾	5¾	15½	10	–
30400WHI10PK	Standard Bin	16¾	7¼	5¾	15½	6¾	5¾	15½	10	–
30400GRY10PK	Standard Bin	16¾	7¼	5¾	15½	6¾	5¾	15½	10	–
30420WHI6PK	Dividable Bin	24	5½	7	22½	3½	7	22¾	6	40420/12
30420GRY6PK	Dividable Bin	24	5½	7	22½	3½	7	22¾	6	40420/12

One color per carton: Specify color when ordering. Order in carton quantities. Weight capacity per bin is 40 lbs.

## Economy Bins

NESTING & STACKING SHELF BIN



- **VERSATILE** – Economy Bins make full use of shelf space on 12" or 18" deep shelving and stack to fill space between shelves
- **DURABLE** – Industrial-grade polymer construction
- **EXCLUSIVE** – The only small parts bin that can nest and stack
- **EFFICIENT** – Generous bin opening allows easy access to items

### COLOR

Black

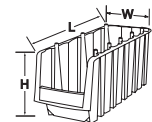

Economy Bins Model No.	Outside Dimensions (In.)			Inside Dimensions (In.)			Ctn. Qty.
	L	W	H	L	W	H	
30796BLACK	8¾	6¾	5	6¾	4	4¾	10
30716BLACK	11¾	6¾	5	9¾	4	4¾	10
30776BLACK	17¾	6¾	7	14¾	3¾	6¾	10
30718BLACK	11¾	8¾	5	9	5¾	4¾	8
30778BLACK	17¾	8¾	7	14¾	5½	6¾	8

Order in carton quantities.



# Indicator® Bin

## TWO-TONED INVENTORY CONTROL BIN

800.253.2467  
akro-mils.com



STORAGE BINS –  
SHELF STYLE

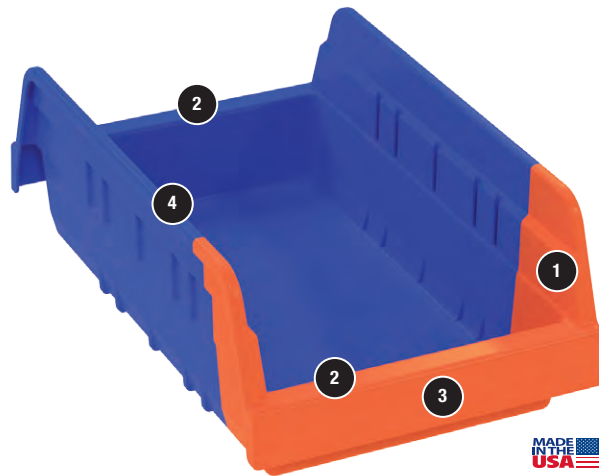

MADE IN THE USA



### FEATURES

- 1 Bright orange trigger color shows low stock levels
- 2 Innovative double-hopper bin can be filled or picked from both sides
- 3 Large label area on both sides of bin
- 4 Rolled ridge provides added strength and durability
- 5 Width dividers (sold separately) used to separate reserve stock

### PRODUCT HIGHLIGHTS

- **INVENTORY CONTROL** – Prevents stockouts with visual recognition when supplies need to be replenished
- **EASY TO USE:**
  - STOCK* – using the divider to designate volume for the inventory reserve
  - PICK* – from the blue side of the bin until you reach the divider
  - FLIP* – the bin to the orange reserve to show inventory levels are low
  - REPLENISH* – the bin and repeat!
- **VALUE** – Low-cost alternative to high-end inventory control systems
- **VARIETY** – Bins available in 4 sizes

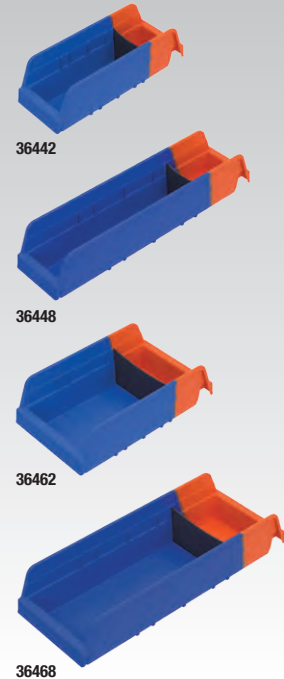

**COLOR**  
Blue/Orange

**BINTELLIGENCE**  
SERIES  
by Akro-Mils



**Stock Pick Flip Replenish**

### Indicator®

Indicator Bins		Outside Dimensions (In.)			Inside Dimensions (In.)			Accessories		
Model No.	Description	L	W	H	L	W	H	Bin Ctn. Qty.	Dividers*	Divider Pkg. Qty.
36442BLUE	Indicator Bin (Blue/Orange)	11%	4%	4	9%	2%	3%	24	40120	24
36448BLUE	Indicator Bin (Blue/Orange)	17%	4%	4	16%	2%	3%	12	40442	12
36462BLUE	Indicator Bin (Blue/Orange)	11%	6%	4	9%	5%	3%	12	40130	24
36468BLUE	Indicator Bin (Blue/Orange)	17%	6%	4	16%	5%	3%	12	40462	12

\*Dividers sold separately.

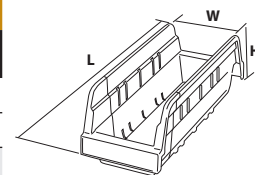

### RELATED PRODUCTS

Create the perfect storage solution – mix and match your Indicator Bins with these products



**33-35** Pick Rack Systems

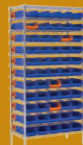

**46-48** Wire Shelving Systems



**49-51** Steel Shelving Systems



# System Bins™

## SINGLE-PIECE, 6-COMPARTMENT STORAGE UNIT

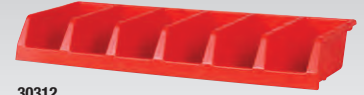
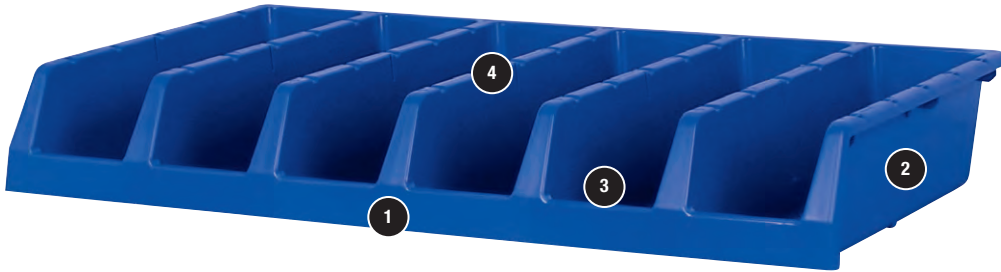

30312



30318

### COLORS

Red, Yellow, Blue



## FEATURES

- 1 Large label area for easy content identification
- 2 Smooth surfaces make the bin easy to fill and keep clean
- 3 Wide hopper front allows easy access for quick parts picking
- 4 Sturdy, double-wall construction for strength and durability

## PRODUCT HIGHLIGHTS

- **SINGLE-PIECE** – Configured six-across in a single unit, 33" wide by 5" high
- **VALUE** – A cost-effective alternative to flimsy, individual cardboard boxes
- **DURABLE** – Sturdy interior double-wall construction. One-piece, injection-molded
- **STACKABLE** – Can be safely stacked using a 3/8" wood dowel rod (not included)
- **NESTABLE** – Bins nest when empty to conserve space
- **VARIETY** – Available in 12" or 18" depths. Colors: Red, Yellow, Blue

## SystemBins™

System Bins		Dimensions (In.)			Bin Compartment Dimensions (In.)**			Ctn. Qty.
Model No.	Description	L	W	H	L	W	H	
30312	12" System Bin	12	33	5	10 $\frac{1}{2}$	3 $\frac{1}{2}$	4 $\frac{1}{16}$	5
30318	18" System Bin	18	33	5	16 $\frac{1}{2}$	3 $\frac{1}{2}$	4 $\frac{1}{16}$	5
40312*	System Bin Divider (Black only)	$\frac{1}{2}$	4 $\frac{7}{8}$	4 $\frac{7}{8}$	–	–	–	6 pk.

One color per carton: Specify Red, Blue or Yellow. Order in carton quantities. \*One divider per compartment, six per unit. \*\*Bottom inside dimension per compartment.

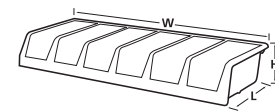

## ACCESSORIES

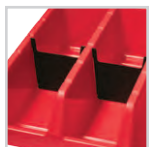

**System Bin Divider**  
Width dividers create additional storage options

## RELATED PRODUCTS

System Bins work with these products



33-35 Pick Rack Systems

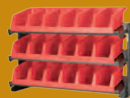

33-35 Bench Pick Rack



46-48 Wire Shelving Systems



49-51 Steel Shelving Systems



60 Shelf Carts





# AkroDrawers®

## HEAVY-DUTY STORAGE DRAWERS

800.253.2467  
akro-mils.com



STORAGE BINS -  
SHELF STYLE

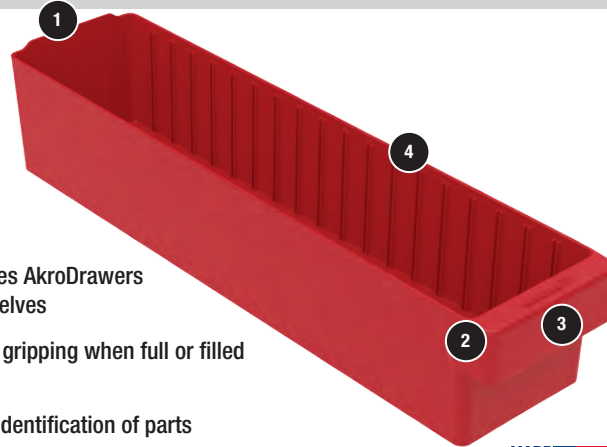

### FEATURES

- 1 Sturdy backstop tab ensures AkroDrawers can hang securely from shelves
- 2 Wide front handle for easy gripping when full or filled with heavy contents
- 3 Large label area for quick identification of parts
- 4 Multiple divider slots allow for customized storage solutions

### PRODUCT HIGHLIGHTS

- **PARTS PROTECTION** – AkroDrawers help keep your supplies, tools and parts secure and dust-free
- **FUNCTIONAL** – Drawers can be used with Akro-Mils' Super Modular Cabinets, Stackable Cabinets, Secure Mini-Cabinets, Louvered Carts, Pick Racks and Enclosed Steel Shelving
- **DURABLE** – Color drawers made of high-impact polystyrene; Crystal Clear drawers made of a durable acrylic blend
- **STACKABLE** – AkroDrawers can be stacked to optimize space
- **VARIETY** – Available in 9 sizes and 5 colors: Red, Yellow, Blue, Crystal Clear, Gray

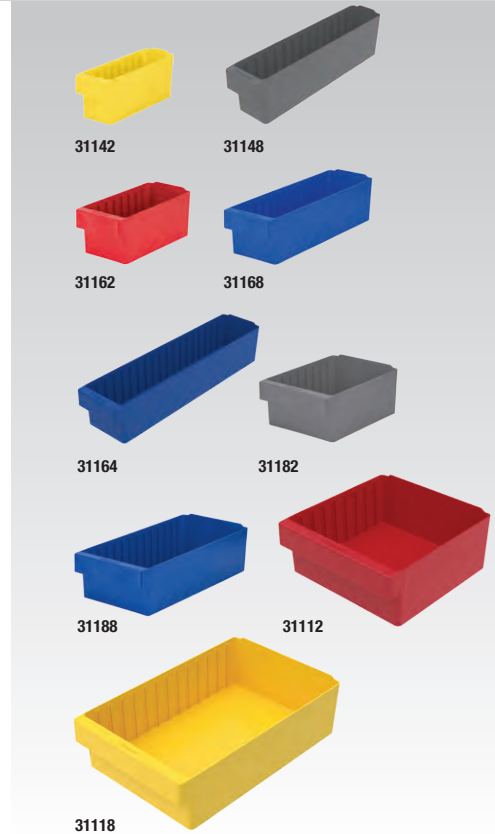

### COLORS

Red, Yellow, Blue, Crystal Clear, Gray



### AkroDrawers®

AkroDrawers Model No.	Outside Dimensions (In.)			Inside Dimensions (In.)			Capacity/Qty.		Dividers	Pkg. Qty
	L	W	H	L	W	H	Weight Capacity	Ctn. Qty.		
31142	11 $\frac{1}{2}$	3 $\frac{3}{4}$	4 $\frac{5}{8}$	10 $\frac{1}{4}$	3 $\frac{1}{2}$	4 $\frac{1}{8}$	15 lbs.	6	41440	6
31148	17 $\frac{1}{2}$	3 $\frac{3}{4}$	4 $\frac{5}{8}$	16 $\frac{1}{4}$	3 $\frac{1}{2}$	4 $\frac{1}{8}$	20 lbs.	6	41440	6
31162	11 $\frac{1}{2}$	5 $\frac{5}{8}$	4 $\frac{5}{8}$	10 $\frac{1}{4}$	4 $\frac{7}{8}$	4 $\frac{1}{8}$	20 lbs.	6	41460	6
31168	17 $\frac{1}{2}$	5 $\frac{5}{8}$	4 $\frac{5}{8}$	16 $\frac{1}{4}$	4 $\frac{7}{8}$	4 $\frac{1}{8}$	25 lbs.	6	41460	6
31164	23 $\frac{1}{2}$	5 $\frac{5}{8}$	4 $\frac{5}{8}$	22 $\frac{1}{2}$	4 $\frac{7}{8}$	4 $\frac{1}{8}$	25 lbs.	6	41460	6
31182	11 $\frac{1}{2}$	8 $\frac{1}{8}$	4 $\frac{5}{8}$	10 $\frac{1}{4}$	7 $\frac{1}{8}$	4 $\frac{1}{8}$	20 lbs.	4	41480	6
31188	17 $\frac{1}{2}$	8 $\frac{1}{8}$	4 $\frac{5}{8}$	16 $\frac{1}{4}$	7 $\frac{1}{8}$	4 $\frac{1}{8}$	25 lbs.	4	41480	6
31112	11 $\frac{1}{2}$	11 $\frac{1}{2}$	4 $\frac{5}{8}$	10 $\frac{1}{4}$	10 $\frac{1}{8}$	4 $\frac{1}{8}$	25 lbs.	4	41410	8
31118	17 $\frac{1}{2}$	11 $\frac{1}{2}$	4 $\frac{5}{8}$	16 $\frac{1}{4}$	10 $\frac{1}{8}$	4 $\frac{1}{8}$	25 lbs.	4	41410	8

Specify drawer color when ordering: Red, Blue, Yellow, Gray or Crystal Clear.

### ACCESSORIES

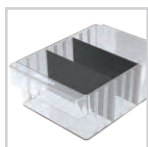

**Width Dividers**  
Available for all sizes!



**Adhesive Labels**  
Adhesive labels are ideal for content identification and form a permanent bond with bins. (See Pg. 11)

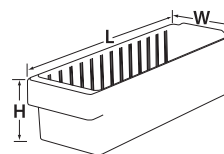

### RELATED PRODUCTS

Create the perfect storage solution — mix and match your AkroDrawers with these products

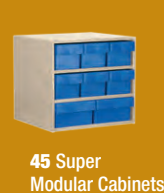



# Nest & Stack Totes

EXTREMELY DURABLE INDUSTRIAL-GRADE TOTES



## FEATURES

- 1 Smooth surfaces are easy to clean
- 2 Comfortable grip makes handling easy
- 3 Ribs under the lip prevent jamming when nested
- 4 Textured bottoms provide a no-slip grip on conveyor belts
- 5 Wide stacking ledge allows totes to securely stack without lids in place
- 6 Lids have tie holes for extra security

## PRODUCT HIGHLIGHTS

- **FUNCTIONAL** – Ideal for shipping, transfer and storage applications
- **STACKBLE** – NSTs stack with or without lids for storage and shipping
- **NESTABLE** – Totes nest when empty
- **DURABLE** – Strong, industrial-grade polymer will not rust, corrode or bend out of shape even when fully loaded
- **COST-EFFECTIVE** – Long service life resulting in lower replacement costs
- **FDA-SANCTIONED** – NSTs are manufactured from FDA-sanctioned materials
- **VARIETY** – Available in 9 sizes and 3 colors: Red, Blue, Gray
- **CUSTOMIZE** – Custom colors and hot stamping available



## COLORS

Red, Blue, Gray



800.253.2467  
akro-mils.com

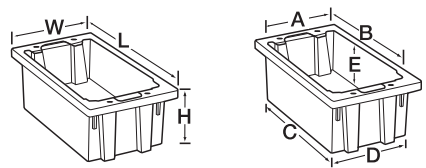

Nest & Stack Totes (NSTs)	Outside Dimensions (In.)			Inside Dimensions (In.)					Capacity/Qty.				Accessories			
	Model No.	L	W	H	A	B	C	D	E	Cu. Ft.	Gal	Lbs.	Tote Ctn. Qty.	Stacking Height	Lid Model	Lid Ctn. Qty.
35180	18	11	6	10	16	15¼	9¾	5¾	0.5	3.7	45	6	6	35181	6	-
35185	18	11	9	10	16	15¼	9¾	8¾	0.76	5.69	60	6	6	35181	6	-
35190	19½	15½	10	14½	17	16	13¼	9¾	1.2	9	65	6	6	35191	6	-
35195	19½	15½	13	14½	17	15¼	13¾	12¾	1.7	12.93	85	6	6	35191	6	-
35200	19½	13½	8	12¾	17¾	16¾	11½	7¾	0.8	6.1	55	6	6	35201	6	-
35225	23½	19½	10	18¼	20¾	19¾	16¾	9¾	2	14.98	70	3	6	35231	3	RU843HR1822
35230	23½	19½	13	18¾	20¾	19½	16¾	12¾	2.6	19.4	90	3	6	35231	3	RU843HR1822
35240	23½	15½	12	14¼	20¾	19¾	13	11¾	1.7	12.9	75	3	6	35241	3	RU843HR1422
35300	29½	19½	15	18¼	26¾	25¾	16¾	14¾	3.7	27.4	100	3	6	35301	3	RU843HR1828

One color per carton. Specify color: Red, Blue or Gray. Order in carton quantities.

Label Holders		
Model No.	Pkg. Qty.	Label Size (In.)
35010	6	3¼ x 5
35011	6	3 x 5

### ACCESSORIES



**Lids**  
Protect contents from dust and damage, include tie holes



**Clear Plastic Label Holders**  
Accommodate labels up to 3¾" x 5"

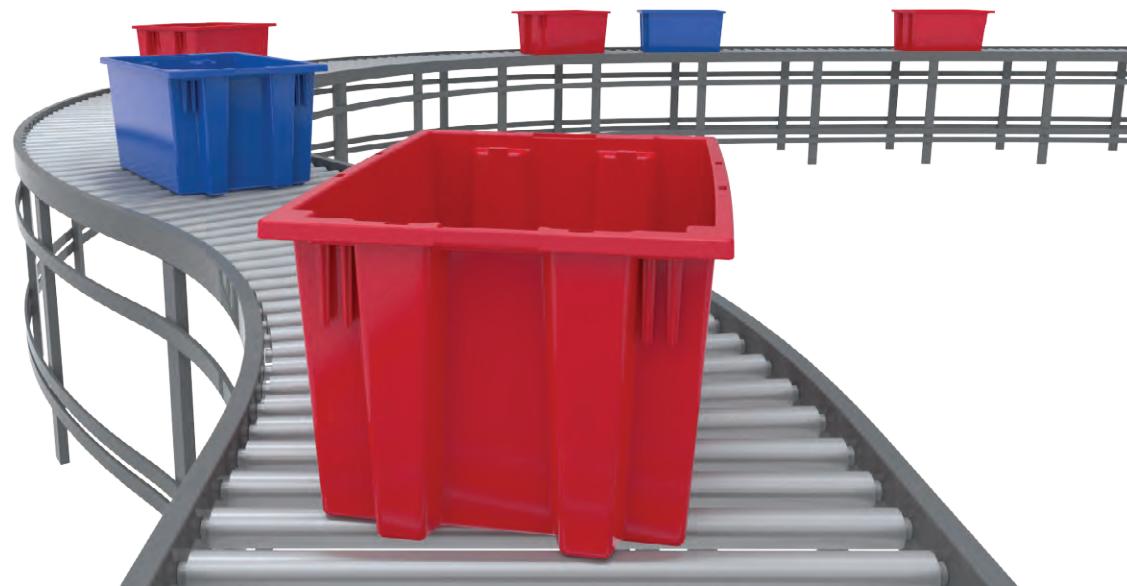

**RELATED PRODUCTS**  
Create the perfect storage solution. Combine Nest & Stack Totes with



**46-48** Wire Shelving Systems



**58** ProCart



**67** Dollies





# Akro-Grid

## DIVIDABLE GRID CONTAINERS

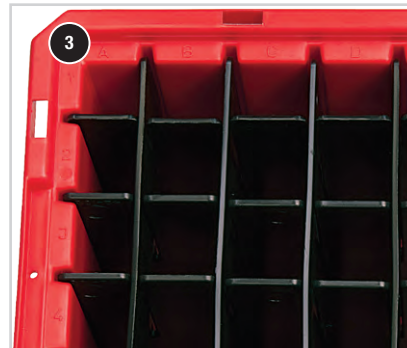
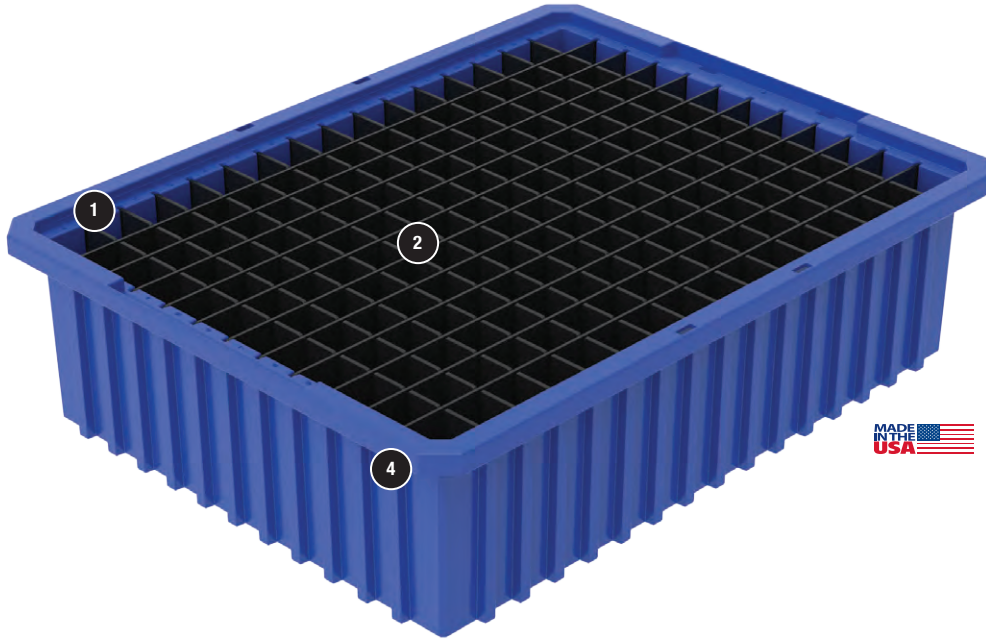

### COLORS

Red, Blue, Clear, Gray



## FEATURES

- 1 Divider slots allow you to create hundreds of compartment sizes
- 2 Dividers (sold separately) allow subdivision of the containers to a 1 1/8" square compartment size
- 3 Molded-in letter/number system for easy parts tracking
- 4 Strong stacking rims and external ribbing provide added strength

## PRODUCT HIGHLIGHTS

- **FUNCTIONAL** – Compatible with most racks, shelving and automated storage retrieval systems
- **DURABLE** – Injection-molded from industrial-grade polymers. Resists most solvents and chemicals
- **COST-EFFECTIVE** – Longer service life resulting in lower replacement costs
- **VARIETY** – Available in 9 sizes and 4 colors: Red, Blue, Clear, Gray
- **CUSTOMIZE** – Custom colors and hot stamping available



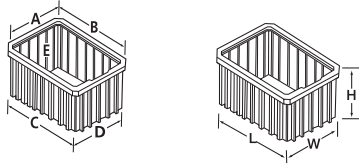

Akro-Grids Model No.	Outside Dimensions (In.)			Inside Dimensions (In.)					Capacity/Qty.				Accessories				
	L	W	H	A	B	C	D	E	Cu. Ft.	Gal	Lbs.	Bin Ctn. Qty.	Long Divider*	Short Divider*	Divider Pkg. Qty.	Max. No. of Compartments	Steel Dollies
33105	10 $\frac{3}{8}$	8 $\frac{1}{4}$	5	6 $\frac{1}{16}$	9 $\frac{1}{16}$	9 $\frac{1}{16}$	6 $\frac{1}{2}$	4 $\frac{1}{8}$	.16	1.2	25	20	42105 (5)	41105 (7)	6	48	–
33164	16 $\frac{1}{2}$	10 $\frac{3}{8}$	4	9 $\frac{1}{16}$	14 $\frac{3}{16}$	14 $\frac{13}{16}$	9 $\frac{1}{16}$	3 $\frac{1}{8}$	.29	2.2	20	12	42164 (7)	41164 (11)	6	96	–
33166	16 $\frac{1}{2}$	10 $\frac{3}{8}$	6	9 $\frac{1}{16}$	14 $\frac{1}{8}$	14 $\frac{3}{8}$	9 $\frac{1}{16}$	5 $\frac{1}{16}$	.44	3.3	35	8	42166 (7)	41166 (11)	6	96	–
33168	16 $\frac{1}{2}$	10 $\frac{3}{8}$	8	9 $\frac{1}{16}$	14 $\frac{3}{16}$	14 $\frac{3}{8}$	9 $\frac{1}{16}$	7 $\frac{1}{16}$	.59	4.4	40	6	42168 (7)	41168 (11)	6	96	–
33220	22 $\frac{1}{2}$	17 $\frac{3}{8}$	10	15 $\frac{1}{4}$	20 $\frac{1}{8}$	19 $\frac{3}{8}$	14 $\frac{3}{8}$	9 $\frac{1}{8}$	1.66	12.4	50	2	42220 (11)	41220 (15)	6	192	RU843HR1621
33223	22 $\frac{1}{2}$	17 $\frac{3}{8}$	3	15 $\frac{1}{16}$	20 $\frac{1}{2}$	20 $\frac{7}{16}$	15 $\frac{3}{8}$	2 $\frac{1}{2}$	.47	3.5	30	6	42223 (11)	41223 (15)	6	192	RU843HR1621
33224	22 $\frac{3}{8}$	17 $\frac{3}{8}$	4	15 $\frac{1}{16}$	20 $\frac{1}{8}$	20	15	3 $\frac{1}{8}$	.61	4.6	30	6	42224 (11)	41224 (15)	6	192	RU843HR1621
33226	22 $\frac{3}{8}$	17 $\frac{3}{8}$	6	15 $\frac{1}{16}$	20 $\frac{1}{8}$	19 $\frac{3}{8}$	14 $\frac{3}{8}$	5 $\frac{1}{8}$	.96	7.2	40	4	42226 (11)	41226 (15)	6	192	RU843HR1621
33228	22 $\frac{3}{8}$	17 $\frac{3}{8}$	8	15 $\frac{1}{16}$	20 $\frac{1}{8}$	19 $\frac{3}{8}$	14 $\frac{3}{8}$	7 $\frac{1}{16}$	1.30	9.7	50	3	42228 (11)	41228 (15)	6	192	RU843HR1621

One color per carton. Specify Red, Blue, Gray or Clear. Order in carton quantities. \*() = max # of dividers.

Clear Snap-On Lids		
Model No.	Fits Grid No.	Ctn. Qty.
33011	33105	10
33061	33164, 33166, 33168	4
33023	33220, 33223, 33224, 33226, 33228	3

Label Holders		
Model No.	Fits Grid No.	Pkg. Qty.
35010	Fits all except 33164, 33223, 33224	6
35011	33164, 33224	6

Adhesive Label		
Model No.	Fits Grid No.	Pkg. Qty.
29203	33223	10 sheets (120 total)

## ACCESSORIES



**Dividers**  
Allow subdivision of the containers down to 1 $\frac{1}{8}$ " square compartments



**Clear Plastic Label Holders**  
Snap securely on any side of the container (except 33223)



**Clear Snap-On Lids**  
Durable injection-molded lids keep contents clean yet visible

## RELATED PRODUCTS

Create the perfect storage solution, pair your Akro-Grids with



46-48 Wire Shelving Systems



58 ProCart



67 Dollies



# Attached Lid Containers : KeepBox™

## DISTRIBUTION CONTAINERS/STORAGE BOXES

### Attached Lid Containers

#### INDUSTRIAL-GRADE

#### FEATURES

- 1 Textured bottoms provide a sure grip on conveyor belts
- 2 Strong molded-in handle grips are ergonomically designed for easy lifting and carrying
- 3 Padlock eye on both ends accommodate security ties
- 4 Reinforced hinge pins for years of smooth lid operation

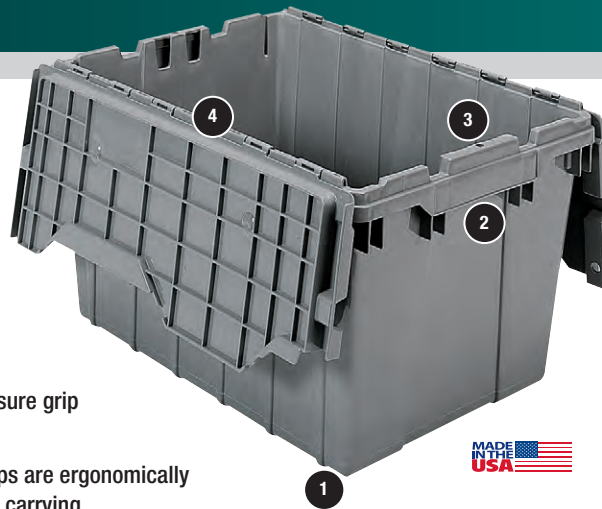

#### COLORS

Red, Blue, Green, Gray



#### PRODUCT HIGHLIGHTS

- **FUNCTIONAL** – Reusable shipping, distribution, order picking and storage containers
- **SECURE** – Attached lids snap securely closed to protect contents from dust and damage
- **INTERWORKING** – Containers interwork for easy pallet loading
- **STACKABLE and NESTABLE** – Containers stack on closed lids and nest in open lids
- **VARIETY** – 6 sizes and 4 colors. See the chart below for color options per model
- **CUSTOMIZE** – Custom colors and hot stamping available

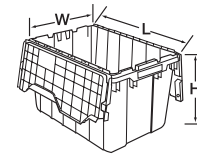

Attached Lid Containers (ALCs)		Outside Dimensions (In.)			Inside Dimensions Top (In.)			Inside Dimensions Bottom (In.)		Capacity/Qty.				Accessories	
Model No.	Available Colors	L	W	H	L	W	H	L	W	Cu. Ft.	Gal.	Lbs.	Container Ctn. Qty.	Stack Cap./Qty. Stacked	Steel Dollies
39085	Blue, Gray	21½	15	9	19¾	14½	8%	18⅞	13¼	1.12	8.5	35	6	35 lbs./5	RU843HR1420
39120	Blue, Green, Red, Gray	21½	15	12½	19¾	14½	12	18⅞	13¼	1.62	12	65	6	65 lbs./5	RU843HR1420
39160	Gray	27	17	12½	25	15½	11	23½	14	2.25	16.83	100	1	100 lbs./4	–
39170	Blue, Gray	21½	15	17	19¾	14½	16%	18⅞	13¼	2.28	17	100	3	100 lbs./3	RU843HR1420
39175	Gray	24	19½	12½	22	18	11	20½	16½	2.3	17.20	80	1	80 lbs./5	–
39280	Gray	28	21	15½	26	19	14	25	18	3.82	28.57	100	1	100 lbs./4	–

Order in carton quantities. Specify color when ordering.

### KeepBox™

#### LIGHT-DUTY STORAGE

#### PRODUCT HIGHLIGHTS

- **FUNCTIONAL** – Secure, dust-free storage
- **NESTABLE** – Containers nest when empty
- **CLEAR** – Sides keep contents visible
- **REINFORCED** – Hinge pins for years of smooth lid operation



#### COLOR

Blue/Clear



KeepBox		Outside Dimensions (In.)			Inside Dimensions Top (In.)			Inside Dimensions Bottom (In.)		Capacity/Qty.				
Model No.	Description	L	W	H	L	W	H	L	W	Cu. Ft.	Gal.	Lbs.	Ctn. Qty.	Stack Cap./Qty. Stacked
66486CLDBL	12 gal. KeepBox	21½	15	12½	19¾	14½	12	17%	12¾	1.60	12	25	6	5

Order in carton quantities.





# Straight Wall Containers

## INDUSTRIAL REUSABLE CONTAINERS

800.253.2467  
akro-mils.com

HEAVY-DUTY TOTES  
& CONTAINERS



MADE IN THE USA



37208



37678



37682



37616

### COLORS

Red, Gray



## FEATURES

- 1 1" wall thickness for secure stacking
- 2 Strong 1" wide stacking rims and external ribbing provide added strength
- 3 Straight walls provide efficient cubing in trucks and on pallets
- 4 Open .72 x .90 mesh pattern allows high visibility and good airflow
- 5 Large handles on 4 sides for easy and comfortable grip

## PRODUCT HIGHLIGHTS

- **FUNCTIONAL** – Reusable shipping, storage and work-in-process containers
- **SOLID** – Smooth inner walls for easy, sanitary cleaning
- **MESH** – Allow air ventilation and drainage
- **DURABLE** – Injection-molded from industrial-grade polymers
- **VARIETY** – Available in 12 configurations, 4 sizes and 2 colors: Red, Gray
- **CUSTOMIZE** – Custom colors and hot stamping available

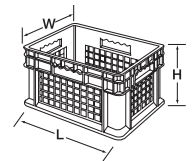

Straight Wall Containers (SWCs)			Outside Dimensions (In.)			Inside Dimensions Bottom (In.)			Capacity/Qty.			Stacked Capacity/Qty.		Accessories
Model No. Mesh Side & Base	Model No. Mesh Side/Solid Base	Model No. Solid Side & Base	L	W	H	L	W	H	Cu. Ft.	Gal.	Container Ctn. Qty.	Solid Bottom	Mesh Bottom	Steel Dollies
37208	37278	37288	15¾	11¾	8¾	14	10	8	0.89	5.12	12	83 lbs./6	30 lbs./6	–
37608	37678	37688	23¾	15¾	8¾	22	14	8	1.78	11.19	4	83 lbs./6	45 lbs./6	RU843HR1624
37612	37672	37682	23¾	15¾	12¾	22	14	12	2.67	8.32	3	125 lbs./5	45 lbs./5	RU843HR1624
37616	37676	37686	23¾	15¾	16¾	22	14	16	3.55	11.07	2	150 lbs./4	45 lbs./4	RU843HR1624

Order in carton quantities. Specify color when ordering.

## RELATED PRODUCTS

Add more productivity to your Straight Wall Containers with



46-48 Wire Shelving Systems



67 Dollies

# Akro-Tubs

IDEAL FOR FOOD PROCESSING, INDUSTRIAL ACTIVITIES

## FEATURES

- 1 Rolled top rim forms comfortable handles
- 2 Extra-thick walls for superior strength
- 3 Rounded corner design adds strength to stress points
- 4 Ribs prevent jamming when nested



## PRODUCT HIGHLIGHTS

- **FDA-SANCTIONED** – Tub manufactured from FDA-sanctioned materials
- **SMOOTH SURFACE** – Easy to clean
- **NESTABLE** – Nests when empty to conserve space
- **CAPACITY** – 75-lb. weight capacity per tub
- **AKRO-TUB RACK** – Use the Akro-Tub Rack (RA6TR4MR) to provide easy loading and transport of multiple tubs

Akro-Tub	Dimensions (In.)					Capacity/Qty.			
Model No.	L	W	H	A	B	Cu. Ft.	Gal.	Lbs.	Ctn. Qty.
34240	19	24½	9½	20½	15½	1.95	14.6	75	6
RA6TR4MR	24	24	73	–	–	–	–	600	–

Order in carton quantities.

COLOR  
Gray

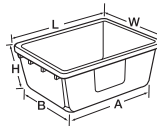

## AKRO-TUB RACK

**Model No. RA6TR4MR**  
Holds 6 Akro-Tubs for up to 600 lb. total capacity. Welded steel frame with 12-gauge base and bolted-on casters (Akro-Tubs sold separately). Casters: 4" x 2" Mold-On Rubber: 2 Rigid, 2 Swivel



UP TO  
**600**  
LBS.

## Cross-Stack Akro-Tub

### FEATURES

- 1 Stacking grooves allow stable 90° stacks
- 2 Molded-in handles for easy lifting
- 3 Extra-thick walls and reinforcing ribs provide superior strength



### PRODUCT HIGHLIGHTS

- **FDA-SANCTIONED** – Tub manufactured from FDA-sanctioned materials
- **FUNCTIONAL** – Industrial-grade tub is compatible with standard 36" shelving and conveyor systems
- **NESTABLE** – Nesting when empty conserves storage space
- **STACKABLE** – Cross-stacking
- **SMOOTH SURFACE** – Easy to clean

Cross-Stack Akro-Tub	Outside Dimensions (In.)					Capacity/Qty.			
Model No.	L	W	H	A	B	Cu. Ft.	Gal.	Lbs.	Ctn. Qty.
34301	17¼	11	8	13¼	7¼	0.52	3.85	6	6
34302	17¼	11	12	12¾	7	0.74	5.51	6	6
34303	23¾	17¼	8	19¾	14	1.31	9.81	6	6
34304	23¾	17¼	12	19	13¼	1.92	14.38	6	6
RACR5MR	53	29	62	–	–	–	–	1000	–

Order in carton quantities.

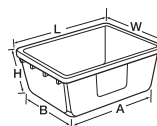

COLOR  
Gray



## DOUBLE-SIDED CROSS-STACK AKRO-TUB RACK

**Model No. RACR5MR**  
Holds (32) 34301 or (16) 34303 Cross-Stack Akro-Tubs (sold separately). Casters: 5" x 2" Mold-On Rubber: 2 Rigid, 2 Swivel



UP TO  
**1000**  
LBS.

# Easy Flow Gravity Hopper

## HOPPER SYSTEM WITH COMPACT VERTICAL DESIGN

800.253.2467  
akro-mils.com



**COLORS**  
Red, Blue



### FEATURES

- 1 Large angled top opening for easy filling
- 2 Generous picking area provides easy access to loaded product
- 3 First-In-First-Out (FIFO) sliding divider shelf for time-sensitive inventory (for 31620 hopper only)

### PRODUCT HIGHLIGHTS

- **FUNCTIONAL** – Allows for proper lot rotation. Great for fasteners, assembly areas, Kanban, inventory stock, merchandise and work cells
- **CAPACITY** – 31620: 50 lbs.; 31625: 75 lbs.
- **DURABLE** – Rotational-molded for strength and durability
- **VARIETY** – Available in 2 sizes and 2 colors. 31625 available in Red and Blue; 31620 available in Blue only

### GRAVITY HOPPER FLOOR RACK

**Model No. 31625RACK**  
Holds 9 large or 12 small hoppers per side. 13-gauge steel powder-coated rack has a 900-lb. weight capacity. Hoppers sold separately



Easy Flow Gravity Hopper		Dimensions (In.)				Capacity/Qty.			
Model No.	Description	L	W	H	D	Cu. In.	Gal.	Lbs.	Ctn. Qty.
31620	Small Easy Flow Gravity Hopper	16	8¾	16	10	1400	6	50	1
31625	Large Easy Flow Gravity Hopper	18	10¾	19½	8	2400	10.39	75	1

When ordering 31625 specify color Red or Blue. † Sliding divider shelf with 31620 hopper only.

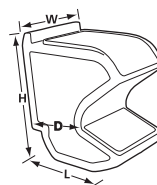

### ACCESSORIES



**30600DOLLY**  
Optional dolly to mobilize 31625RACK has 4 swivel casters (2 with brakes)



**30600BRACKET**  
Optional bracket to hang hoppers from louvered panels or rail racks



Accessories		
Model No.	Description	Wt. Cap.
31625RACK	Easy Flow Gravity Hopper Rack 36" x 36" x 69"	900 lbs.
30600DOLLY	Easy Flow Gravity Hopper Dolly with 4" x 1½" Polyolefin Casters	900 lbs.
30600BRACKET	Easy Flow Gravity Hopper Bracket	75 lbs.





# Small Parts Storage

CUSTOMIZABLE, PORTABLE BOXES

## Storage Cases

GRIDDED LID KEEPS ITEMS IN PLACE

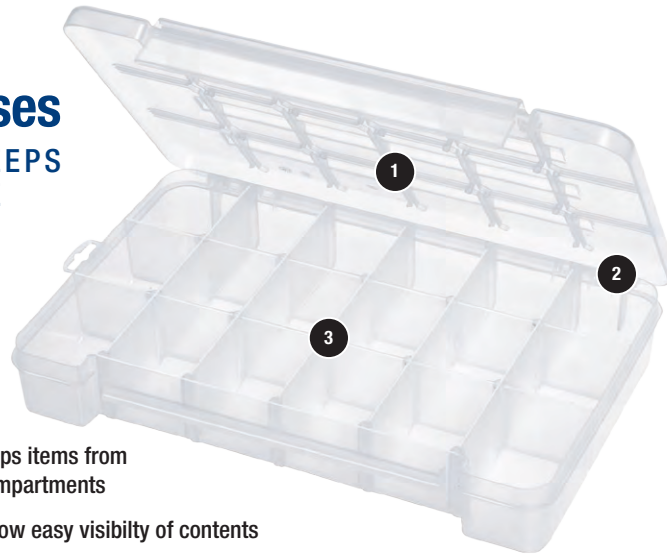

### FEATURES

- 1 Grid design in lid keeps items from spilling into other compartments
- 2 Clear case and lid allow easy visibility of contents
- 3 Dividers are adjustable for customized storage



### PRODUCT HIGHLIGHTS

- **FUNCTIONAL** – Plastic storage cases are ideal in any setting for parts storage
- **ADJUSTABLE** – Small and medium cases have 4 front-to-back adjustable dividers; large cases include 5 front-to-back adjustable dividers
- **DURABLE** – Molded of clear industrial-grade polymers
- **VARIETY** – Available in 3 sizes with different divider configurations

Storage Cases		Dimensions (In.)			Capacity/Qty.	
Model No.	Description	L	W	H	Max. Compartments	Ctn. Qty.
05705	Small Case – 2 Fixed Dividers	8%	5%	1%	15	12
05805	Medium Case – 2 Fixed Dividers	11	7	2%	15	6
05905	Large Case – 2 Fixed Dividers	14%	9½	2½	18	6

Order in carton quantities.



05705

05805



05905

### COLOR

Clear



### Small & Medium Cases

2 Fixed Dividers	4 Adjustable Dividers
------------------	-----------------------

2 Fixed Dividers  
4 Adjustable Dividers

### Large Cases

2 Fixed Dividers	5 Adjustable Dividers
------------------	-----------------------

2 Fixed Dividers  
5 Adjustable Dividers

## ProBox™ Toolboxes

- **FUNCTIONAL** – 14" unit includes removable tool tray and metal latch\*
- **DURABLE** – No-nonsense, professional toolboxes
- **SECURE** – 14" unit features oversized padlock eye for securing tools
- **VARIETY** – Available in 2 sizes



ProBox Toolbox		Dimensions (In.)			Ctn. Qty.
Model No.	Description	L	W	H	Ctn. Qty.
09912*	12" ProBox	12	6	4	12
09514	14" ProBox	14	8%	8%	6

Order in carton quantities. \*12" unit does not include tray.



09514



09912

### COLOR

Red





# Small Parts Storage

PORTABLE ORGANIZERS : TOOLBOXES : ROTO-SHELF : TOTE CADDY

800.253.2467  
akro-mils.com



MADE IN THE USA

## Portable Organizers

- **FUNCTIONAL** – Unique design keeps parts and equipment from migrating to other compartments when the lid is shut
- **DIVIDABLE** – Adjustable dividers included for customized storage in both levels
- **VERSATILE** – Main compartment for large items and lid compartment for small items
- **DURABLE** – Made from durable polymers
- **VARIETY** – Available in 2 sizes

**COLOR**  
Blue/Clear



Portable Organizers		Dimensions (In.)			Capacity/Qty.	
Model No.	Description	L	W	H	Maximum Compartments	Ctn. Qty.
06115	Lid Storage Organizer	15	11 $\frac{3}{8}$	3 $\frac{1}{4}$	11 to 46	1
06118	Large Lid Storage Organizer	18 $\frac{1}{4}$	13 $\frac{3}{8}$	3 $\frac{3}{8}$	12 to 62	1

Order in carton quantities.



UP TO 300 LBS.

MADE IN THE USA

## Roto-Shelf

- **MOBILE** – Roto-Shelf can be moved easily to different work areas; ideal for assembly components
- **FUNCTIONAL** – 24 individual storage compartments
- **COMPACT** – 19 $\frac{7}{8}$ " wide unit takes up little floor space
- **ROTATING** – 3 shelves rotate on an independent central metal shaft
- **CAPACITY** – 75 lbs. per shelf, 300 lbs. total capacity

**COLOR**  
Black/Red



Roto-Shelf		Dimensions (In.)			
Model No.	Description	D	H	Caster	Ctn. Qty.
02420	Roto-Shelf	19 $\frac{7}{8}$	37 $\frac{1}{2}$	3" Polyurethane	1

Order in carton quantities.



MADE IN THE USA

## Tote Caddy

- **COMPACT** – Hand-held tool and supply caddy
- **FUNCTIONAL** – Deep compartments hold loose parts, cleaning supplies or tools for easy transport
- **DURABLE** – Molded of heavy-duty, industrial-grade polymers for lasting durability

**COLOR**  
Blue, Clear



Tote Caddy		Dimensions (In.)			
Model No.	Description	L	W	H	Ctn. Qty.
09185BLUE	Tote Caddy	13 $\frac{3}{8}$	18 $\frac{3}{8}$	9	6
09185SCLAR	Tote Caddy	13 $\frac{3}{8}$	18 $\frac{3}{8}$	9	6

Order in carton quantities.

NEW!

AVAILABLE IN CLEAR





# Louvered Hanging Systems

CUSTOMIZABLE VERTICAL STORAGE FOR HANGING BINS



## FEATURES

- 1 Louvered Panels securely support AkroBins® and InSight® Bins (sold separately, see Pgs. 4, 9)
- 2 Heavy-duty 16-gauge, cold-rolled steel for strength and durability
- 3 Attractive, durable powder-coated finish
- 4 Save installation time with Rivet Racks! Models 30661, 30638 and 30676 are full louvered panels mounted to a convenient heavy-duty frame



## PRODUCT HIGHLIGHTS

- **EFFICIENT** – Wall-mounted units keep items out of the way, off the floor and off the work table
- **BENCH RACKS** – Used on work tables to keep parts within easy reach
- **FLOOR RACKS** – Can be placed near work areas to improve productivity
- **SINGLE-SIDED RACKS** – Can be placed against a wall to save floor space
- **DOUBLE-SIDED RACKS** – Expand storage options
- **MOBILE KIT** – Available to mobilize two-sided racks

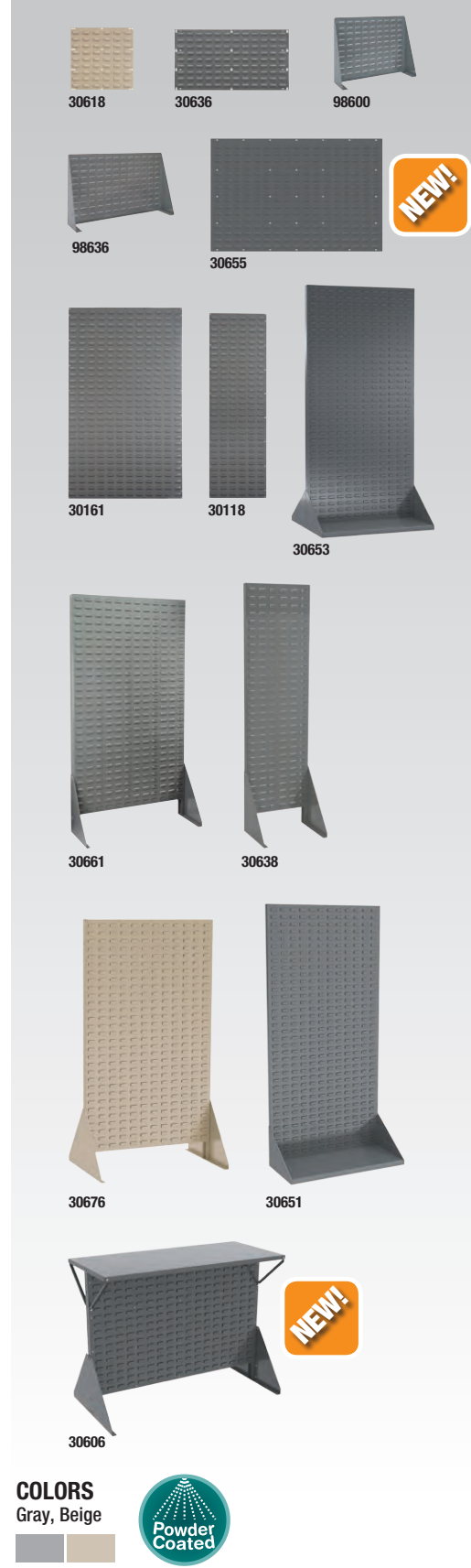

**COLORS**  
Gray, Beige



AkroBin Louvered Hanging Systems			Dimensions (In.)				Rack Wt. Cap. (lbs.)	AkroBin quantity to fit Louvered Hanging System – AkroBins Model No. (Bin Weight Capacity)									
Model No.	Description	Ctn. Qty	L	W	H	30210 (10 lbs.)		30220 (10 lbs.)	30224 (30 lbs.)	30230 (30 lbs.)	30234 (50 lbs.)	30235 (60 lbs.)	30239 (50 lbs.)	30240 (60 lbs.)	30250 (75 lbs.)	30255 (60 lbs.)	30320 (80 lbs.)
30618*	Louvered Panel	4	18	5/8	19	160	16	16	12	9	9	3	4	4	2	3	–
30636*	Louvered Panel	4	35 3/4	5/8	19	160	32	32	24	18	18	9	8	8	4	6	3
	2 Louvered Panels		35 3/4	5/8	37	–	72	72	36	36	36	18	16	16	8	12	5
	3 Louvered Panels		35 3/4	5/8	55	–	104	104	54	54	54	27	28	28	14	18	8
	4 Louvered Panels		35 3/4	5/8	73	–	144	144	72	72	72	36	36	36	18	24	11
30655	Louvered Panel	1	52	5/8	34 1/2	750	96	96	60	45	45	20	24	24	12	15	5
98600*	Bench Rack	1	27 5/8	8 3/8	19 1/8	120	30	30	18	12	12	6	6	6	–	–	–
98636	Bench Rack	1	36	8	20	120	40	40	24	18	18	9	8	8	4	6	3
30161*	Louvered Panel	1	36	5/8	61	1000	120	120	80	60	60	30	28	28	14	20	10
30118	Louvered Panel	1	18	5/8	61	500	48	48	36	30	30	14	12	12	6	9	–
30653	Heavy-Duty Double-Sided Floor Rack	1	35 3/4	32	75 1/2	2000	288	288	192	144	144	72	72	72	36	48	–
30661*	Single-Sided Rivet Floor Rack	1	36 3/8	13 1/2	66 3/8	500	120	120	80	60	60	30	28	28	14	20	10
30638	Single-Sided Rivet Floor Rack	1	18	13 1/2	66 3/8	250	48	48	36	30	30	14	12	12	6	9	–
30676*	Double-Sided Rivet Floor Rack	1	36 3/8	25	66 3/8	1000	240	240	144	108	108	56	48	48	24	36	20
30651	Heavy-Duty Single-Sided Floor Rack	1	35 3/4	17	75 1/2	1000	144	144	98	72	72	36	36	36	18	24	11
30653DOLLY	Mobile Kit for 30653	1	–	–	–	500	–	–	–	–	–	–	–	–	–	–	–
LVDMOBILE	Mobile Kit for 30676	1	–	–	–	1500	–	–	–	–	–	–	–	–	–	–	–

\*Also available in Beige.

Low Profile Floor Rack – Single-Sided		Rack Dimensions (In.)			Bin Dimensions (In.)				Wt. Capacity (Lbs.)		
Model No.	Description	W	H	D	Bin Model No.	L	W	H	Bin Qty.	Panel/Top	Colors
30650GY	Low Profile Floor Rack	52 1/2	40	13 1/2	–	–	–	–	–	500/250	–
30650GY240	Low Profile Floor Rack	52 1/2	40	13 1/2	30240	14 3/4	8 1/4	7	24	500/250	B, R, Y, SC
30650GY250	Low Profile Floor Rack	52 1/2	40	13 1/2	30250	14 3/4	16 1/2	7	12	500/250	B, R, Y, SC
30650GYASST	Low Profile Floor Rack	52 1/2	40	13 1/2	30240 / 30250	See Above			12/6	500/250	B, R, Y, SC
30656GY	Low Profile Floor Rack no Shelf	52 1/2	39 1/2	13 1/2	–	–	–	–	–	500	B, R, Y, SC
30656GY240	Low Profile Floor Rack no Shelf	52 1/2	39 1/2	13 1/2	30240	14 3/4	8 1/4	7	24	500	B, R, Y, SC
30656GY250	Low Profile Floor Rack no Shelf	52 1/2	39 1/2	13 1/2	30250	14 3/4	16 1/2	7	12	500	B, R, Y, SC
30656GYASST	Low Profile Floor Rack no Shelf	52 1/2	39 1/2	13 1/2	30240 / 30250	See Above			12/6	500	B, R, Y, SC

Specify color of bins when ordering. B=Blue, R=Red, Y=Yellow, SC=Clear.

Low Profile Floor Rack – Double-Sided		Rack Dimensions (In.)			Bin Dimensions (In.)				Wt. Capacity (Lbs.)		
Model No.	Description	W	H	D	Bin Model No.	L	W	H	Bin Qty.	Panel/Top	Colors
30606GY	Low Profile Floor Rack	52 1/2	40	27	–	–	–	–	–	500 per side/250	–
30606GY240	Low Profile Floor Rack	52 1/2	40	27	30240	14 3/4	8 1/4	7	48	500 per side/250	B, R, Y, SC
30606GY250	Low Profile Floor Rack	52 1/2	40	27	30250	14 3/4	16 1/2	7	24	500 per side/250	B, R, Y, SC
30606GYASST	Low Profile Floor Rack	52 1/2	40	27	30240 / 30250	See Above			24/12	500 per side/250	B, R, Y, SC
30607GY	Low Profile Floor Rack no Shelf	52 1/2	39 1/2	27	–	–	–	–	–	500	B, R, Y, SC
30607GY240	Low Profile Floor Rack no Shelf	52 1/2	39 1/2	27	30240	14 3/4	8 1/4	7	48	500	B, R, Y, SC
30607GY250	Low Profile Floor Rack no Shelf	52 1/2	39 1/2	27	30250	14 3/4	16 1/2	7	24	500	B, R, Y, SC
30607GYASST	Low Profile Floor Rack no Shelf	52 1/2	39 1/2	27	30240 / 30250	See Above			24/12	500	B, R, Y, SC

Specify color of bins when ordering. B=Blue, R=Red, Y=Yellow, SC=Clear.

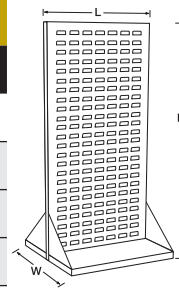

InSight Louvered Panel Systems		
Model No.	Description	Bin Qty.
30636BEIGE A1	35 3/4" x 19" Louvered Panel with 305A1	32
30636BEIGE A3	35 3/4" x 19" Louvered Panel with 305A3	32
30636BEIGE A5	35 3/4" x 19" Louvered Panel with 305A5	32
30636BEIGE B1	35 3/4" x 19" Louvered Panel with 305B1	18

InSight Louvered Panel and Bin Combinations		Bin Qty.			
Model No.		305A1	305A3	305A5	305B1
30618BEIGE		16	16	16	9
98600BEIGE		30	30	30	12

Bins sold separately.

## LOW-PROFILE LOUVERED FLOOR RACK



**30650GYASST**  
Available with or without top shelf;  
single- or double-sided.







# Lean Panel™ : Lean Floor Rack

## 15° LOUVERED HANGING SYSTEM



800.253.2467  
akro-mils.com

**NEW!**

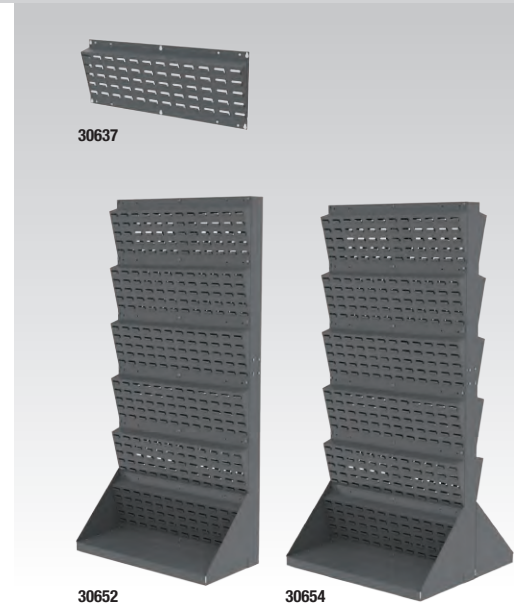
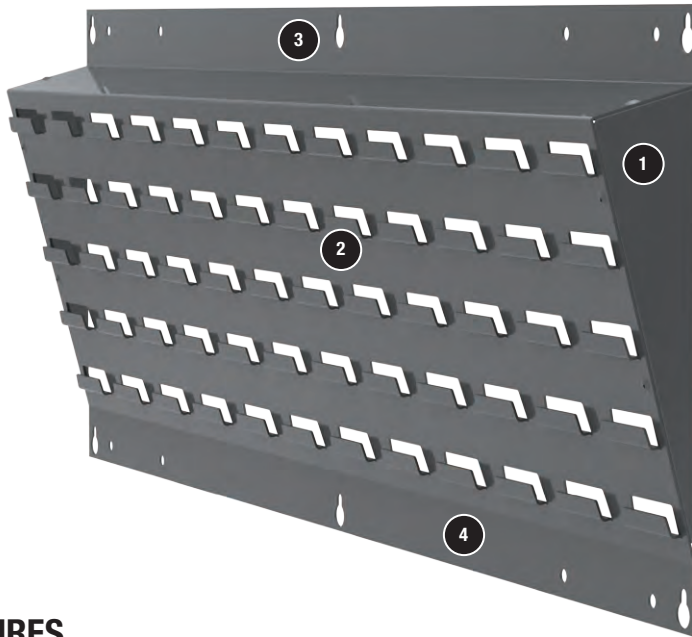

**COLOR**  
Gray



### FEATURES

- 1 Keeps hanging bins at an ergonomic 15-degree angle for easier visibility and more comfortable picking
- 2 Louvers allow for easy placement of AkroBins®, InSight® Bins, or ProHANGER®
- 3 Individual panels can be wall mounted or used with floor standing racks
- 4 Durable powder-coated finish on heavy-duty 16-gauge steel



Lean Panel & Lean Panel Floor Rack		Dimensions (In.)			
Model No.	Description	L	W	H	Weight Capacity
30637A	Lean Panel – 1 PACK	35½	2½	13¼	90 lbs.
30637	Lean Panel – 3 PACK	35½	2½	13¼	90 lbs. ea.
30652	Single-Sided Floor Rack	35¾	17	75¾	500 lbs.
30654	Double-Sided Floor Rack	35¾	32	75¾	1000 lbs.
30653DOLLY	Mobile Kit for Floor Rack	–	–	–	500 lbs.

AkroBin Quantities for Lean Panel & Lean Panel Floor Rack									
Model No.	30210, 30220	30224	30230, 30234	30239, 30240, 30265	30235	30260	30255	30250, 30270	30320
30637A	24	16	12	4	6	3	4	2	2
30652	144	96	72	24	36	18	24	12	12
30654	288	192	144	48	72	36	48	24	24



30654 with 30653DOLLY (Bins sold separately)





# ReadySpace® Storage System

## BIN HANGING SYSTEMS FOR MEDICAL & HEALTHCARE

800.253.2467  
akro-mils.com

BIN HANGING  
SYSTEMS & RACKS

**Ready, Set, Organize!®**

### PRODUCT HIGHLIGHTS

- **FUNCTIONAL** – Wall, Bench or Mobile Floor Units free up valuable workspace!
- **CLEAN** – Durable white powder-coated finish creates a neat, attractive storage space in any healthcare and medical environment
- **MOBILE UNIT** – Casters come standard with the Mobile Floor Unit
- **WALL UNIT** – Ships complete with its own mounting bracket for easy installation
- **BENCH UNIT** – 2-piece base allows for assembly as a single- or double-sided unit
- **VARIETY** – Preconfigured packages with Stone AkroBins® are available, or create your own system using AkroBins and InSight® Bins!

ReadySpace Wall Unit Packages		Capacity/Qty.		
Model No.	Description (L x W x H)	No. of Ctns.	Wt. Cap. (lbs.)	Bin Qty.
30536	37½" x 13¼" x 25¾" Panel	1	50	N/A
30536210S	Unit with 30210STONE Bins	3	50	48
30536220S	Unit with 30220STONE Bins	3	50	48
30536230S	Unit with 30230STONE Bins	3	50	24
30536235S	Unit with 30235STONE Bins	3	50	12
30536320S	Unit with 30320STONE Bins	2	50	4
30536A1	ReadySpace Wall Unit with 305A1	4	50	48
30536A3	ReadySpace Wall Unit with 305A3	4	50	48
30536A5	ReadySpace Wall Unit with 305A5	5	50	48
30536B1	ReadySpace Wall Unit with 305B1	3	50	24

ReadySpace Mobile Floor Unit Packages		Capacity/Qty.		
Model No.	Description (L x W x H)	No. of Ctns.	Wt. Cap. (lbs.)	Bin Qty.
30553	24¾" x 23" x 52"	1	150	N/A
30553210S	Unit with 30210STONE Bins	6	150	120
30553220S	Unit with 30220STONE Bins	6	150	120
30553230S	Unit with 30230STONE Bins	6	150	60
30553235S	Unit with 30235STONE Bins	6	150	30
30553A1	ReadySpace Mobile Floor Unit with 305A1	9	150	120
30553A3	ReadySpace Mobile Floor Unit with 305A3	9	150	120
30553A5	ReadySpace Mobile Floor Unit with 305A5	11	150	120
30553B1	ReadySpace Mobile Floor Unit with 305B1	7	150	64
30553LF	Leveling Feet for Floor Unit	-	150	-



COLOR  
White



ReadySpace Bench Unit Packages		Capacity/Qty.		
Model No.	Description	No. of Ctns.	Wt. Cap. (lbs.)	Bin Qty.
98536	37¾" x 12" x 26¾" (Single)	1	100	N/A
98536210SS	Single-Sided Bench Unit with 30210STONE Bins	3	100	48
98536220SS	Single-Sided Bench Unit with 30220STONE Bins	3	100	48
98536230SS	Single-Sided Bench Unit with 30230STONE Bins	3	100	24
98536235SS	Single-Sided Bench Unit with 30235STONE Bins	3	100	12
98536320SS	Single-Sided Bench Unit with 30320STONE Bins	2	100	4
98536	37¾" x 22½" x 26¾" (Double)	1	100	N/A
98536210SD	Double-Sided Bench Unit with 30210STONE Bins	5	100	96
98536220SD	Double-Sided Bench Unit with 30220STONE Bins	5	100	96
98536230SD	Double-Sided Bench Unit with 30230STONE Bins	5	100	48
98536235SD	Double-Sided Bench Unit with 30235STONE Bins	5	100	24
98536320SD	Double-Sided Bench Unit with 30320STONE Bins	3	100	8



# Rail Hanging Systems

## IDEAL SYSTEMS FOR WORKSTATIONS



### FEATURES

- 1 14-gauge steel rails securely support AkroBins®, 19-Series Cabinets and InSight® Ultra-Clear Bins (sold separately)
- 2 Heavy-duty steel for strength and durability
- 3 Durable powder-coated finish

### PRODUCT HIGHLIGHTS

- **EFFICIENT** – Allow for fast, easy organization and parts retrieval
- **SINGLE-SIDED** – Units are ideal for placement against a wall to save space
- **DOUBLE-SIDED** – Units can “float” in any room environment and can be picked from both sides
- **MOBILE KIT** – Available to mobilize two-sided rack
- **STEEL RAIL** – Wall mountable rail is ideal for supply rooms and workstations



Rail Hanging Systems				Dimensions (In.)			AkroBins Model No. (Bin Weight Capacity)‡										InSight Bins (Bin Weight Capacity)				19-Series Cabinets
Model No.	Description	Wt. Cap.	Ctn. Qty.	L	W	H	30210 (10 lbs.)	30220 (10 lbs.)	30224 (30 lbs.)	30230 (30 lbs.)	30234 (50 lbs.)	30235 (50 lbs.)	30239 (50 lbs.)	30240 (60 lbs.)	30250 (75 lbs.)	30255 (60 lbs.)	305A1 (10 lbs.)	305A3 (10 lbs.)	305A5 (15 lbs.)	305B1 (25 lbs.)	
30008*	Rack, 1-Sided	250	1	36	14½	53	96	96	48	48	48	24	24	24	12	16	96	96	96	48	6
30016*	Rack, 2-Sided	500	1	36	20	53	192	192	96	96	96	48	48	48	24	32	192	192	192	96	12
30148	Steel Rail	110	1	47¾	¾	3	11	11	11	8	8	4	4	4	2	2	11	11	11	8	2
30812	Bin Cart	250	1	38½	24	36½	96	96	64	48	48	24	24	24	12	16	96	96	96	48	12

\*Can be assembled as a 12 or 16 rail rack. ‡Do not exceed rail weight capacity.

Mobile Kit					
Model No.	Description	Wt. Cap.	Ctn. Qty.	Fits Hanging System No.	Castors
30424	Mobile Kit - Casters & Handle	500	1	30016	4" Polyolefin
98400	Suspension Straps (Set of 2) ‡‡	–	1	30008, 30016, 30812	

‡‡ 98400 suspension straps required for hanging 19-Series Cabinets. Two straps per cabinet needed to secure cabinet to rack.

### ACCESSORIES

**Suspension Straps Model No 98400**  
Hang 19-Series Cabinets securely to rail rack



30016 with (1) 30424, (12) 98400, (12) 19320

# Pick Racks

HIGH-DENSITY STORAGE WITH ANGLED SHELVES

800.253.2467  
akro-mils.com



APRBENCH



APRS



APRD18

COLOR  
Gray



## FEATURES

- 1 16-gauge steel construction
- 2 Angled shelves keep parts at the front of bin
- 3 Works with Akro-Mils' industry-leading Shelf Bins, ShelfMax® Bins, Indicator® Bins, AkroDrawers® and System Bins™
- 4 Durable, powder-coated finish

## PRODUCT HIGHLIGHTS

- **EFFICIENT** – Improve workspace organization and efficiency
- **HEAVY-DUTY** – Up to 1,800 lb. capacity with Double-Sided 18" Racks
- **VARIETY** – Choose from 3 styles: Single-Sided, Double-Sided, Bench, and two shelf depths: 12" and 18"

12" Deep Pick Rack 12" D x 36 3/4" W x 60 1/4" H				Shelf Dimensions (in.)		
Model No.	Description	Wt. Capacity (Lbs.)	Caster	D	L	H
APRS	Single-Sided Pick Rack (no bins)	400	–	12 1/2	35 1/2	6 1/8
APRD	Double-Sided Pick Rack (no bins)	800	–	12 1/2	35 1/2	6 1/8
APRDMOBILE	Mobile Kit (Handle & Dolly) for Double-Sided Pick Rack	500	4" x 1 1/2" Polyolefin	–	–	–

Bench Rack 12" D x 36 3/4" W x 25" H			Bin Dimensions (in.)			
Model No.	Description	Bin Model No.	L	W	H	Bin Qty.
APRBENCH	Bench Pick Rack, No Bins	–	–	–	–	–
APRBENCH120*	Bench Pick Rack with Shelf Bins	30120	11 1/2	4 1/2	4	24
APRBENCH150*	Bench Pick Rack with Shelf Bins	30150	11 1/2	8 1/2	4	12
APRBENCH040**	Bench Pick Rack with ShelfMax	30040	11 1/2	4 1/2	6	24
APRBENCH090**	Bench Pick Rack with ShelfMax	30090	11 1/2	6 1/2	6	15
APRBENCH312	Bench Pick Rack with System Bins	30312	12	33	5	3

\*Specify color of Shelf Bins when ordering: Red, Blue, Yellow, Green or White. \*\*Specify color of ShelfMax Bins when ordering: Red, Blue, Yellow, Gray or Crystal Clear.

18" Deep Pick Rack 18" D x 36 3/4" W x 60 1/4" H				Shelf Dimensions (in.)		
Model No.	Description	Wt. Capacity (Lbs.)	Caster	D	L	H
APRS18	Single-Sided Pick Rack (no bins)	900*	–	18 1/2	35 1/2	6 1/8
APRD18	Double-Sided Pick Rack (no bins)	1800**	–	18 1/2	35 1/2	6 1/8
APRD18MOBILE	Mobile Kit (Handle & Dolly) for Double-Sided Pick Rack	1800	5" x 2" Phenolic	–	–	–

\*When anchored to wall and floor. \*\*When anchored to floor.



# Pick Rack Systems

## 12" DEEP ANGLED SHELVES

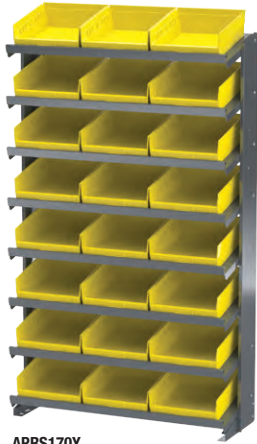

APRS170Y

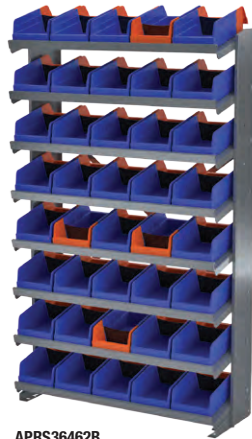

APRS36462B



APRD080G



APRD182CRY



APRD312R

12" Deep Single-Sided Pick Rack			Bin Dimensions (In.)			Bin Qty.	Colors
Model No.	Description	Bin Model No.	L	W	H		
<b>Shelf Bins</b>							
APRS110	Rack with Shelf Bins	30110	11%	2¾	4	96	B,R,Y,G,W,SC
APRS120	Rack with Shelf Bins	30120	11%	4%	4	64‡	B,R,Y,G,W,SC
APRS130	Rack with Shelf Bins	30130	11%	6%	4	40‡	B,R,Y,G,W,SC
APRS150	Rack with Shelf Bins	30150	11%	8%	4	32‡	B,R,Y,G,W,SC
APRS170	Rack with Shelf Bins	30170	11%	11%	4	24	B,R,Y,G,W,SC
<b>ShelfMax Bins</b>							
APRS040	Rack with ShelfMax	30040	11%	4%	6	64	B,R,Y,G,W,SC
APRS080	Rack with ShelfMax	30080	11%	8%	6	32	B,R,Y,G,W,SC
APRS090	Rack with ShelfMax	30090	11%	6%	6	40	B,R,Y,G,W,SC
APRSAST00	Rack with ShelfMax	30040 / 30090	See above			32 / 20	B,R,Y,G,W,SC
<b>Indicator Bins</b>							
APRS36442B	Rack with Indicator Bins	36442BLUE	11%	4%	4	64‡	B
APRS36462B	Rack with Indicator Bins	36462BLUE	11%	6%	4	40‡	B
<b>AkroDrawers</b>							
APRS112	Rack with AkroDrawers	31112	11%	11%	4%	24	B,R,Y,GRY,CRY
APRS142	Rack with AkroDrawers	31142	11%	3%	4%	72	B,R,Y,GRY,CRY
APRS162	Rack with AkroDrawers	31162	11%	5%	4%	48	B,R,Y,GRY,CRY
APRS182	Rack with AkroDrawers	31182	11%	8%	4%	32	B,R,Y,GRY,CRY
APRSAST	Rack with AkroDrawer Mix	31142, 31162, 31182	See Above			18 / 24 / 8	B,R,Y,GRY,CRY
<b>System Bins</b>							
APRS312	Rack with System Bins	30312	12	33	5	8‡	B,R,Y

Specify color of bins when ordering. ‡Bonus bins included. B=Blue, R=Red, Y=Yellow, G=Green, W=White, SC=Clear, GRY=Gray, CRY=Crystal Clear.

12" Deep Double-Sided Pick Rack			Bin Dimensions (In.)			Bin Qty.	Colors
Model No.	Description	Bin Model No.	L	W	H		
<b>Shelf Bins</b>							
APRD110	Rack with Shelf Bins	30110	11%	2¾	4	192	B,R,Y,G,W,SC
APRD120	Rack with Shelf Bins	30120	11%	4%	4	128‡	B,R,Y,G,W,SC
APRD130	Rack with Shelf Bins	30130	11%	6%	4	80‡	B,R,Y,G,W,SC
APRD150	Rack with Shelf Bins	30150	11%	8%	4	64‡	B,R,Y,G,W,SC
APRD170	Rack with Shelf Bins	30170	11%	11%	4	48	B,R,Y,G,W,SC
<b>ShelfMax Bins</b>							
APRD040	Rack with ShelfMax	30040	11%	4%	6	128	B,R,Y,G,W,SC
APRD080	Rack with ShelfMax	30080	11%	8%	6	64	B,R,Y,G,W,SC
APRD090	Rack with ShelfMax	30090	11%	6%	6	80	B,R,Y,G,W,SC
APRDAST00	Rack with ShelfMax	30040 / 30090	See above			64 / 40	B,R,Y,G,W,SC
<b>Indicator Bins</b>							
APRD36442B	Rack with Indicator Bins	36442BLUE	11%	4%	4	128‡	B
APRD36462B	Rack with Indicator Bins	36462BLUE	11%	6%	4	80‡	B
<b>AkroDrawers</b>							
APRD112	Rack with AkroDrawers	31112	11%	11%	4%	48	B,R,Y,GRY,CRY
APRD142	Rack with AkroDrawers	31142	11%	3%	4%	144	B,R,Y,GRY,CRY
APRD162	Rack with AkroDrawers	31162	11%	5%	4%	96	B,R,Y,GRY,CRY
APRD182	Rack with AkroDrawers	31182	11%	8%	4%	64	B,R,Y,GRY,CRY
APRDAST	Rack with AkroDrawer Mix	31142, 31162, 31182	See Above			36 / 48 / 16	B,R,Y,GRY,CRY
<b>System Bins</b>							
APRD312	Rack with System Bins	30312	12	33	5	16‡	B,R,Y

Specify color of bins when ordering. ‡Bonus bins included. B=Blue, R=Red, Y=Yellow, G=Green, W=White, SC=Clear, GRY=Gray, CRY=Crystal Clear.



# Pick Rack Systems

## 18" DEEP ANGLED SHELVES

800.253.2467  
akro-mils.com

BIN HANGING  
SYSTEMS & RACKS

**NEW!**

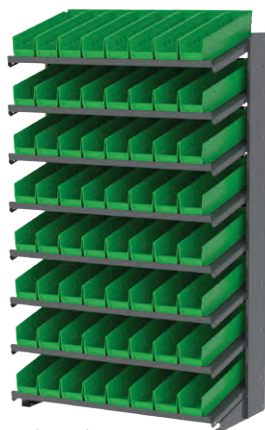

APRS18128G

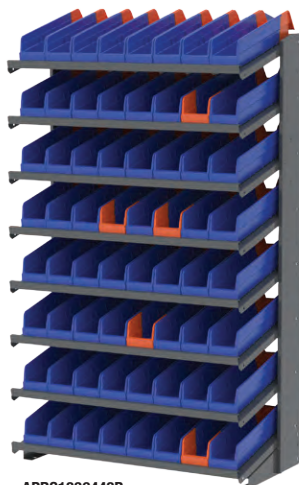

APRS1836448B

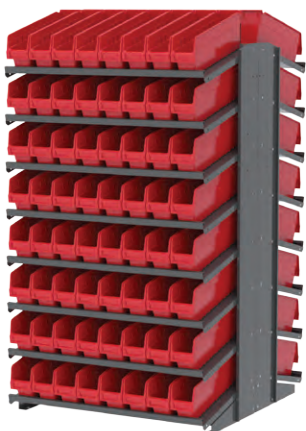

APRD18048R



APRD18148B

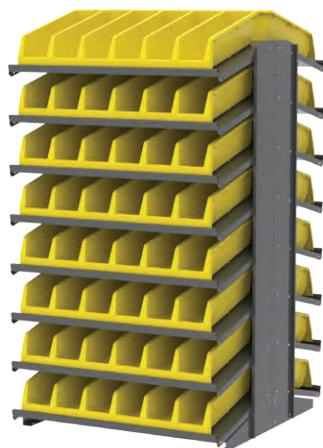

APRD18318Y

18" Deep Single-Sided Pick Rack			Bin Dimensions (In.)			Bin Qty.	Colors
Model No.	Description	Bin Model No.	L	W	H		
<b>Shelf Bins</b>							
APRS18128	Rack with Shelf Bins	30128	17%	4%	4	72‡	B,R,Y,G,W,SC
APRS18138	Rack with Shelf Bins	30138	17%	6%	4	48‡	B,R,Y,G,W,SC
APRS18158	Rack with Shelf Bins	30158	17%	8%	4	36‡	B,R,Y,G,W,SC
APRS18178	Rack with Shelf Bins	30178	17%	11%	4	24	B,R,Y,G,W,SC
<b>ShelfMax Bins</b>							
APRS18048	Rack with ShelfMax	30048	17%	4%	6	64	B,R,Y,G,W,SC
APRS18088	Rack with ShelfMax	30088	17%	8%	6	32	B,R,Y,G,W,SC
APRS18098	Rack with ShelfMax	30098	17%	6%	6	40	B,R,Y,G,W,SC
APRS18AST00	Rack with ShelfMax	30048 / 30098	See above			32/20	B,R,Y,G,W,SC
<b>Indicator Bins</b>							
APRS1836448	Rack with Indicator Bins	36448BLUE	17%	4%	4	72‡	B
APRS1836468	Rack with Indicator Bins	36468BLUE	17%	6%	4	48‡	B
<b>AkroDrawers</b>							
APRS18148	Rack with AkroDrawers	31148	17%	3%	4%	72	B,R,Y,GRY,CRY
APRS18168	Rack with AkroDrawers	31168	17%	5%	4%	48	B,R,Y,GRY,CRY
APRS18188	Rack with AkroDrawers	31188	17%	8%	4%	32	B,R,Y,GRY,CRY
APRS18118	Rack with AkroDrawers	31118	17%	11%	4%	24	B,R,Y,GRY,CRY
<b>System Bins</b>							
APRS18318	Rack with System Bins	30318	18	33	5	8‡	B,R,Y

Specify color of bins when ordering. ‡Bonus bins included. B=Blue, R=Red, Y=Yellow, G=Green, W=White, SC=Clear, GRY=Gray, CRY=Crystal Clear.

18" Deep Double-Sided Pick Rack			Bin Dimensions (In.)			Bin Qty.	Colors
Model No.	Description	Bin Model No.	L	W	H		
<b>Shelf Bins</b>							
APRD18128	Rack with Shelf Bins	30128	17%	4%	4	132‡	B,R,Y,G,W,SC
APRD18138	Rack with Shelf Bins	30138	17%	6%	4	84‡	B,R,Y,G,W,SC
APRD18158	Rack with Shelf Bins	30158	17%	8%	4	72‡	B,R,Y,G,W,SC
APRD18178	Rack with Shelf Bins	30178	17%	11%	4	48	B,R,Y,G,W,SC
<b>ShelfMax Bins</b>							
APRD18048	Rack with ShelfMax	30048	17%	4%	6	128	B,R,Y,G,W,SC
APRD18088	Rack with ShelfMax	30088	17%	8%	6	64	B,R,Y,G,W,SC
APRD18098	Rack with ShelfMax	30098	17%	6%	6	80	B,R,Y,G,W,SC
APRD18AST00	Rack with ShelfMax	30048 / 30098	See above			64/40	B,R,Y,G,W,SC
<b>Indicator Bins</b>							
APRD1836448	Rack with Indicator Bins	36448BLUE	17%	4%	4	132‡	B
APRD1836468	Rack with Indicator Bins	36468BLUE	17%	6%	4	84‡	B
<b>AkroDrawers</b>							
APRD18148	Rack with AkroDrawers	31148	17%	3%	4%	144	B,R,Y,GRY,CRY
APRD18168	Rack with AkroDrawers	31168	17%	5%	4%	96	B,R,Y,GRY,CRY
APRD18188	Rack with AkroDrawers	31188	17%	8%	4%	64	B,R,Y,GRY,CRY
APRD18118	Rack with AkroDrawers	31118	17%	11%	4%	48	B,R,Y,GRY,CRY
<b>System Bins</b>							
APRD18318	Rack with System Bins	30318	18	33	5	16‡	B,R,Y

Specify color of bins when ordering. ‡Bonus bins included. B=Blue, R=Red, Y=Yellow, G=Green, W=White, SC=Clear, GRY=Gray, CRY=Crystal Clear.





# TiltView®

## TILTING BINS OFFER VISIBLE, DUST-FREE STORAGE

**NEW!**



### FEATURES

- 1 Cabinets made of high-impact polystyrene
- 2 Bins made of polystyrene (GPS)
- 3 Molded-in label holder (card stock labels included)
- 4 Neutral Stone color is ideal for any environment
- 5 06702 slides apart to form two separate bins

### PRODUCT HIGHLIGHTS

- **EFFICIENT** – Space-saving system will improve organization and efficiency in a variety of settings, including healthcare and medical!
- **FUNCTIONAL** – Can be used on a desktop, attached to steel rails, frames or louvered panels, and are wall mountable
- **VARIETY** – Available in 6 sizes



06702



06703



06704



06705



06706



06709

**COLOR**  
Stone





800.253.2467  
akro-mils.com

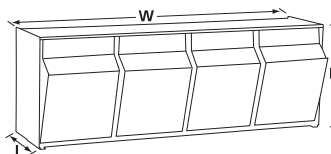

TiltView Bins		Dimensions (In.)			Capacity/Qty.		
Model No.	Description	L	W	H	Ctn. Qty.	Capacity Lbs.	Dividers
06702	2-Bin TiltView	12 <sup>5</sup> / <sub>16</sub>	23 <sup>3</sup> / <sub>8</sub>	14	1	30	–
06703	3-Bin TiltView	7 <sup>7</sup> / <sub>8</sub>	23 <sup>3</sup> / <sub>8</sub>	9 <sup>1</sup> / <sub>16</sub>	1	30	40703 (3/Pk)
06704	4-Bin TiltView	6 <sup>3</sup> / <sub>8</sub>	23 <sup>3</sup> / <sub>8</sub>	8 <sup>3</sup> / <sub>16</sub>	1	25	40704 (4/Pk)
06705	5-Bin TiltView	5 <sup>5</sup> / <sub>8</sub>	23 <sup>3</sup> / <sub>8</sub>	6 <sup>1</sup> / <sub>2</sub>	1	20	–
06706	6-Bin TiltView	3 <sup>3</sup> / <sub>4</sub>	23 <sup>3</sup> / <sub>8</sub>	4 <sup>1</sup> / <sub>2</sub>	1	15	–
06709	9-Bin TiltView	2 <sup>1</sup> / <sub>2</sub>	23 <sup>3</sup> / <sub>8</sub>	3 <sup>3</sup> / <sub>16</sub>	1	5	–

TiltView Accessories		
Model No.	Description	Ctn. Qty.
TVHDWR	TiltView Hardware Pack	1 Set
TVLRA	TiltView Locking Rod	2 Pk.
TVLR	TiltView Locking Rod	12 Pk.
TVCLIP	TiltView Hanging Clip	2 Pk.

TiltView Rails		Dimensions (In.)			Number of Bins to Fit Each Rail Set					
Model No.	Description	L	W	H	06702	06703	06704	06705	06706	06709
TV24R	24" TiltView Rails	1 <sup>1</sup> / <sub>8</sub>	1 <sup>3</sup> / <sub>8</sub>	24 <sup>1</sup> / <sub>8</sub>	1	2	3	3	5	8
TV48R	48" TiltView Rails	1 <sup>1</sup> / <sub>8</sub>	1 <sup>3</sup> / <sub>8</sub>	48 <sup>1</sup> / <sub>8</sub>	3	5	6	7	10	16
TV70R	70" TiltView Rails	1 <sup>1</sup> / <sub>8</sub>	1 <sup>3</sup> / <sub>8</sub>	70 <sup>1</sup> / <sub>8</sub>	5	7	8	10	15	23

One Rail Set = 2 Rails. Bins sold separately; mounting bins requires hardware pack.

TiltView Frames		Dimensions (In.)			Number of Bins to Fit Each Frame					
Model No.	Description	L	W	H	06702	06703	06704	06705	06706	06709
TV24F	24" TiltView Frames	1 <sup>1</sup> / <sub>8</sub>	13 <sup>3</sup> / <sub>8</sub>	24 <sup>1</sup> / <sub>8</sub>	1	2	3	3	5	8
TV48F	48" TiltView Frames	1 <sup>1</sup> / <sub>8</sub>	13 <sup>3</sup> / <sub>8</sub>	48 <sup>1</sup> / <sub>8</sub>	3	5	6	7	10	16
TV70F	70" TiltView Frames	1 <sup>1</sup> / <sub>8</sub>	13 <sup>3</sup> / <sub>8</sub>	70 <sup>1</sup> / <sub>8</sub>	5	7	8	10	15	23

Bins sold separately; mounting bins requires hardware pack.

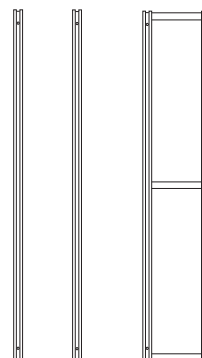

## ACCESSORIES



**Dividers**  
Optional dividers (for 3-Bin and 4-Bin models) expand sorting options



**Locking Rod**  
Model No. TVLR  
Keeps contents secure; rods easily attach to unit, and flip down to keep the bins from opening



**Wall Mount Frames**  
16-gauge steel frames make a system where bin units are easily stacked and removed securely



**Rail Systems**  
16-gauge steel rails convert bins into customizable hanging wall systems



**TiltView Clips**  
Model No. TVCLIP  
Allow easy attachment to Akro-Mils' Louvered Hanging Systems or the ReadySpace® Storage System

## RELATED PRODUCTS

Using the TiltView Clips, bins will attach to the following products



28-30 Louvered Hanging Systems



31 ReadySpace Storage System



32 Rail Hanging Systems



# Steel Storage Cabinets

17-SERIES & 19-SERIES

## 19-Series Cabinets

HEAVY-DUTY VERSATILE CABINET

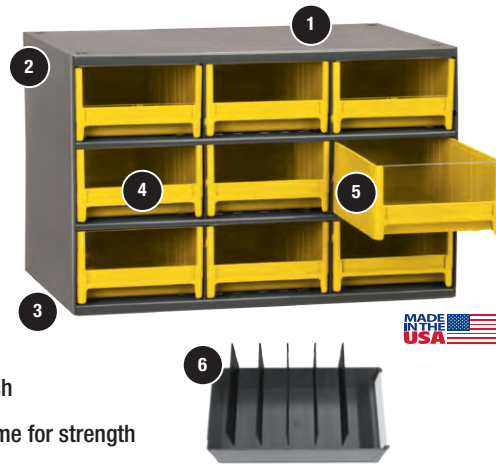

### FEATURES

- 1 Chip-proof, durable powder-coated finish
- 2 Heavy-duty 24-gauge, welded-steel frame for strength
- 3 Built-in nesting feet for safe, stable stacking
- 4 Label holder and transparent window for content identification
- 5 Industrial-grade plastic drawers now available in 5 colors!
- 6 Dovetail dividers lock securely in place and provide up to 8 compartments

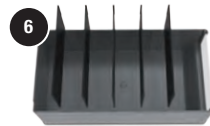

### PRODUCT HIGHLIGHTS

- **FUNCTIONAL** – The perfect choice for easy access and organization of small parts. Cabinet size: 17" wide x 11" deep x 11" high. Drawer depth: 10<sup>9</sup>/<sub>16</sub>"
- **SAFE** – No sharp edges to damage parts. Unique rear stop tab on each drawer prevents spills
- **EXPANDABLE** – Cabinets can be used with Mobile Racks, ProCart™ and Storage-Go-Round
- **WALL-MOUNTABLE** – 4 "keyhole slots" on back for easy wall mounting
- **VARIETY** – Available in 5 models and 5 drawer colors: Red, Blue, Yellow, Gray and Black. Cabinet with locking door also available!



19228



19320



19416



19715



19909



19109

### DRAWER COLORS

Red, Yellow, Blue, Gray, Black



### CABINET COLOR

Gray



19-Series Heavy-Duty Steel Cabinets			Drawer Dimensions (In.)			Accessories		
Model No.	Description	Drawers Per Cabinet‡	W	H	D	Ctn. Qty.	Drawer Model No.	Dividers 25/Pkg. Model No.
19228	Steel Storage Cabinet*	28	2 <sup>3</sup> / <sub>16</sub>	2 <sup>1</sup> / <sub>16</sub>	10 <sup>9</sup> / <sub>16</sub>	1	20228	40228
19320	Steel Storage Cabinet*	20	3 <sup>3</sup> / <sub>16</sub>	2 <sup>1</sup> / <sub>16</sub>	10 <sup>9</sup> / <sub>16</sub>	1	20320	40320
19416	Steel Storage Cabinet*	16	4	2 <sup>1</sup> / <sub>16</sub>	10 <sup>9</sup> / <sub>16</sub>	1	20416	40416
19715	Steel Storage Cabinet*	15	3 <sup>3</sup> / <sub>16</sub>	3 <sup>3</sup> / <sub>16</sub>	10 <sup>9</sup> / <sub>16</sub>	1	20715	40715
19909	Steel Storage Cabinet*	9	5 <sup>3</sup> / <sub>16</sub>	3 <sup>3</sup> / <sub>16</sub>	10 <sup>9</sup> / <sub>16</sub>	1	20909	40909
19109	Storage Cabinet w/ Locking Door	9	5 <sup>3</sup> / <sub>16</sub>	3 <sup>3</sup> / <sub>16</sub>	10 <sup>9</sup> / <sub>16</sub>	1	20909	40909

One drawer color per cabinet. Specify Red, Blue, Yellow, Gray or Black when ordering. ‡ Two removable dividers and one label per drawer included. \*Available with a locking door when ordered in quantities of 50 or more.

## 17-Series Cabinet

ECONOMICAL STEEL FRAME CABINET

- **STEEL FRAME** – 18" wide x 6" deep x 9<sup>1</sup>/<sub>2</sub>" high
- **CRYSTAL CLEAR DRAWERS** – Rust, corrosion and dent-proof

17-Series Light-Duty Steel Cabinets			Drawer Dimensions (In.)			Accessories		
Model No.	Description	Drawers Per Cabinet‡	W	H	D	Ctn. Qty.	Drawer Model No.	Dividers 25/Pkg. Model No.
17018	Storage Cabinet	18	2 <sup>3</sup> / <sub>16</sub>	2 <sup>1</sup> / <sub>16</sub>	5 <sup>3</sup> / <sub>16</sub>	1	20902	40901

‡ One removable divider and one label per drawer included.



# Steel Cabinet Accessories

## MORE HIGH-DENSITY STORAGE OPTIONS

800.253.2467  
akro-mils.com

## Storage-Go-Round

1,000 LBS. OF PARTS IN 1 SQUARE YARD

### FEATURES

- 1 Securely holds (20) 19-Series cabinets
- 2 Small workspace footprint: compact swing diameter 43<sup>5</sup>/<sub>8</sub>"
- 3 Ball-transfer base rotates for easy access to parts
- 4 Durable, powder-coated finish
- 5 Mix or match color options and drawer sizes to take organization to the next level!

### PRODUCT HIGHLIGHTS

- **EFFICIENT** – Streamlines workflow and order picking
- **DUST-FREE** – Cabinets and drawers minimize dust collection
- **CAPACITY** – Holds 20 steel cabinets; weight capacity of 1,000 lbs.
- **VARIETY** – Mix or match steel cabinet drawer colors: Red, Blue, Yellow, Gray, Black

Storage-Go-Round		Assembled Dimensions (In.)			Compatible with Models*	COLOR Gray
Model No.	Description	L	W	H		
98325	Storage-Go-Round with turntable base	31	31	60	19228, 19320, 19416, 19715, 19909	

Assembly required. \* 19-Series Cabinets sold separately.



UP TO  
1000  
LBS.

## Mobile Steel Cabinet Rack

500 LBS. OF PARTS WITHIN REACH

- **VERSATILE** – Double-sided, mobile rail rack holds up to 12 cabinets, with as many as 336 drawers
- **HEAVY-DUTY** – Supports up to 500 lbs.

Mobile Steel Cabinet Rack		
Model No.	Description	Required Components Qty.
30016	Double-Sided Rail Rack – 36" W x 24" D x 57" H	1 each
30424	Mobile Kit	1 each
98400	Suspension Straps (Set of 2) ‡‡	12 sets

Assembly required. See chart above. ‡‡ 98400 suspension straps required for hanging. Two straps per cabinet needed to secure cabinets to rack. Mix/match 12 19-Series Cabinets.



98400

COLOR  
Gray



UP TO  
500  
LBS.



# Plastic Storage Cabinets

ORGANIZE & PROTECT HARDWARE & OFFICE SMALL PARTS



## FEATURES

- 1 Cabinets made of rugged, high-impact plastic
- 2 Clear industrial-grade plastic drawers are unbreakable
- 3 Interlocking cabinet frame and face ensure strength and durability

## PRODUCT HIGHLIGHTS

- **RECYCLED** – Cabinet frames are made of 100 percent recycled material. Make a positive impact on the environment!
- **FUNCTIONAL** – Strong plastic cabinets organize and protect loose items
- **STACKBLE** – Cabinets stack for more storage options
- **WALL-MOUNTABLE** – 4 “keyhole slots” on back for easy wall mounting
- **DIVIDABLE** – A limited number of drawer dividers provided. Additional dividers sold separately
- **VARIETY** – Available in 5 models



10116



10124



10126



10144



10164

## COLOR

Black



Plastic Storage Cabinets		Drawer Qty.		Dimensions (In.)			Ctn. Qty.
Model No.	Description	Large	Small	L	W	H	
10116	16-Drawer Cabinet	0	16	10½	6¾	8½	1
10124	24-Drawer Cabinet	24	0	20	6¾	15¼	1
10126	26-Drawer Cabinet	6	20	20	6¾	10¼	1
10144	44-Drawer Cabinet	12	32	20	6¾	15¼	1
10164	64-Drawer Cabinet	0	64	20	6¾	15¼	1

16-Drawer Cabinet has 8 dividers. All other cabinets have 8 small and 4 large dividers. Large Drawer: 4¾" W x 2" H x 5¼" L. Small Drawer: 2½" W x 1½" H x 5¼" L.

Additional Dividers (Plastic Cabinets)	
Model No.	Description
40716	16-Pack additional dividers for small drawers
40717	6-Pack additional dividers for large drawers



20702 Large Drawer : 4¾" x 2" x 5¼"



20701 Small Drawer : 2½" x 1½" x 5¼"

## RELATED PRODUCTS

Create the perfect storage solution – mix and match your Plastic Storage Cabinets with these products

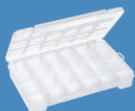

26 Storage Cases



27 Portable Organizers



27 Tote Caddy



36-37 TiltView

# Standard Bin Cabinets

## ALL-WELDED BIN STORAGE CABINETS

800.253.2467  
akro-mils.com



UP TO  
**1500**  
LBS.

### FEATURES

- 1 All-welded cabinets made of 16-gauge steel
- 2 Adjustable shelves hold up to 300 lbs. each
- 3 Louvered back wall panel
- 4 Keyed handle with 3-point locking system



AkroBin Cabinet 36" W x 24" D x 78" H			Bin Dimensions (In.)			Qty. of Bins
Model No.	Description	Bin Model No.	L	W	H	
AC3624	Cabinet w/ Louvered Panels on Back & Doors, no Bins	-	-	-	-	-
AC3624Y	Cabinet w/ Louvered Panels on Back & Doors with Assorted AkroBins	30210YELLO	5%	4%	3	48
		30220YELLO	7%	4%	3	48
		30230YELLO	10%	5½	5	24
		30240YELLO	14%	8%	7	12
		30250YELLO	14%	16½	7	6

AkroBin Cabinet w/ 3 Shelves 36" W x 24" D x 78" H			Bin Dimensions (In.)			Qty. of Bins
Model No.	Description	Bin Model No.	L	W	H	
AC36243AS	Cabinet w/ 3 Shelves, Louvered Panels on Back & Doors, no Bins	-	-	-	-	-
AC3624Y3AS	Cabinet w/ 3 Shelves, Louvered Panels on Back & Doors, with Assorted AkroBins	30210YELLO	5%	4%	3	48
		30220YELLO	7%	4%	3	48
		30250YELLO	14%	16½	7	6

AkroBin Cabinet w/ Flush Doors 36" W x 18" D x 78" H			Bin Dimensions (In.)			Qty. of Bins
Model No.	Description	Bin Model No.	L	W	H	
AC3618	Cabinet w/ Louvered Panels on Back Wall, no Bins	-	-	-	-	-
AC3618Y	Cabinet w/ Louvered Panels on Back Wall, with Assorted AkroBins	30230YELLO	10%	5½	5	24
		30240YELLO	14%	8%	7	12
		30250YELLO	14%	16½	7	6

Quick-View Security Bin Cabinet 36" W x 18" D x 78" H			Bin Dimensions (In.)			Qty. of Bins
Model No.	Description	Bin Model No.	L	W	H	
AC3618QV	Cabinet w/ Quick View Doors, Louvered Back, no Bins	-	-	-	-	-
AC3618QV240	Cabinet w/ Quick View Doors, Louvered Back, with AkroBins	30240YELLO	14%	8%	7	36
AC3618QV250	Cabinet w/ Quick View Doors, Louvered Back, with AkroBins	30250YELLO	14%	16½	7	18

Secure-View Security Bin Cabinet 36" W x 18" D x 78" H			Bin Dimensions (In.)			Qty. of Bins
Model No.	Description	Bin Model No.	L	W	H	
AC3618SV	Cabinet w/ Secure View Mesh Doors, Louvered Back, no Bins	-	-	-	-	-
AC3618SV240	Cabinet w/ Secure View Mesh Doors, Louvered Back, with AkroBins	30240YELLO	14%	8%	7	36
AC3618SV250	Cabinet w/ Secure View Mesh Doors, Louvered Back, with AkroBins	30250YELLO	14%	16½	7	18

Bin Cabinet Dollies		Dimensions (In.)			Polyolefin Casters		Weight Capacity
Model No.	Description	L	W	H			
AC803618M26	18 x 36 Bin Cabinet Dolly	36½	18½	5¼	3 x 1¼"		1000 lbs.
AC803624M26	24 x 36 Bin Cabinet Dolly	36½	24½	6½	4 x 1¼"		1000 lbs.



AkroBin® Cabinet  
Model No. AC3624Y  
Louvered panels on back wall and doors hold up to 138 bins

UP TO  
**1250**  
LBS.



AkroBin® Cabinet with 3 Shelves  
Model No. AC3624Y3AS  
Louvered panels and 3 full 24" shelves hold up to 102 bins

UP TO  
**1500**  
LBS.



AkroBin Cabinet with Flush Doors  
Model No. AC3618Y  
Louvered panel on back wall holds up to 42 bins

UP TO  
**1000**  
LBS.



Quick-View Security Bin Cabinet  
Model No. AC3618QV240  
Lexan™ door panels; louvered back wall panel. Complete with 36 AkroBins. Comes standard in beige

UP TO  
**1000**  
LBS.



Secure View Security Bin Cabinet  
Model No. AC3618SV250  
Steel mesh door panels; louvered back wall panel. Complete with 36 AkroBins.

UP TO  
**1000**  
LBS.



Bin Cabinet Dolly Model No. AC803624M26  
Convert large cabinets to mobile units!

UP TO  
**1000**  
LBS.

COLOR  
Gray



# Ready-To-Assemble Cabinet : Heavy-Duty Cabinets

SPECIALTY STORAGE CABINETS OFFER EVEN MORE OPTIONS



## Ready-To-Assemble Bin Cabinet

SHIPS FLAT TO SAVE \$

### FEATURES

- 1 Cabinets made of 18-gauge steel with powder-coated finish
- 2 Louvered back wall panel
- 3 Flush mount handle with 3-point locking system
- 4 100-lb. capacity shelves adjust every 2"
- 5 Leveling feet

UP TO 1000 LBS.



AC3618KD1ASY



AC3618KD4AS

COLOR  
Gray



Ready-To-Assemble Bin Cabinet 36" W x 19" D x 78" H			Bin Dimensions (In.)			Qty. of Bins
Model No.	Description	Bin Model No.	W	D	H	
AC3618KD4AS	Ready-to-Assemble Cabinet with 4 Adjustable Shelves	-	-	-	-	-
AC3618KD1ASY	Ready-to-Assemble Cabinet with 1 Adjustable Shelf, 30 AkroBins	30230YELLO	10%	5½	5	12
		30240YELLO	14%	8¼	7	12
		30250YELLO	14%	16½	7	6

Optional Accessories		Dimensions (In.)			Weight Capacity
Model No.	Description	W	D	H	
AC3618RT	Rooftop	36	17½	4¾	-
AC3618SHELF1PK	Extra Shelf	36	13	2¼	100 lbs.
AC803618M26	Cabinet Dolly	36½	18½	5¼	1000 lbs.

### ACCESSORIES



#### Rooftop

Prevents potentially hazardous items from being stored on top of the cabinet

## Heavy-Duty Bin Cabinets

ALL-WELDED CONSTRUCTION

### PRODUCT HIGHLIGHTS

- **STURDY** – All-welded 16-gauge steel construction with 7-gauge reinforced corners
- **SECURE** – Heavy-duty steel padlock-ready handle ensures complete security
- **ADJUSTABLE** – Shelves on 2" centers allowing the flexibility of securely storing multiple-sized objects
- **DURABLE** – Powder-coated paint is resistant to cuts and scratches



Heavy-Duty Cabinet 48" W x 24" D x 72" H			Bin Dimensions (In.)			Qty. of Bins	Wt. Capacity (Lbs.)
Model No.	Description	Bin Model No.	L	W	H		
HD4824A	Cabinet w/ Shelves Only	-	-	-	-	-	2000 / 250 / 300
HD4824E	Cabinet w/ Louvered Panels on Back Wall & Doors, with Assorted AkroBins	30220YELLO	7%	4%	3	160	1500 / 250 / -
		30230YELLO	10%	5½	5	24	
		30240YELLO	14%	8¼	7	20	
		30235YELLO	10%	11	5	12	
HD4824F	Cabinet w/ Louvered Panels on Back Wall & Doors, with Assorted AkroBins	30220YELLO	7%	4%	3	160	1500 / 250 / -
		30230YELLO	10%	5½	5	48	
		30240YELLO	14%	8¼	7	20	



Model No. HD4824A

Louvered back wall, cabinet shelves, 4" deep pocket door shelves (no louvers)



Model No. HD4824E

Louvered back wall, louvered doors, bins. Includes 216 assorted AkroBins



Model No. HD4824F

Louvered back wall, louvered doors, bins. Includes 228 assorted AkroBins

COLOR  
Gray





# Secure Mini-Cabinets

LOCKABLE CABINETS HOLD 12" DEEP AKRODRAWERS®

800.253.2467  
akro-mils.com



UP TO  
**350**  
LBS.

## FEATURES

- 1 Cabinets made of 18-gauge steel
- 2 Welded frame and durable powder-coated finish
- 3 Quick-View Door keeps cabinet contents visible
- 4 4 adjustable shelves
- 5 Lockable flush-mount handle (with 2 keys)
- 6 Louvered back panel for hanging storage bins



ACQV4C82R



ACS4C



ACQV4P

## COLORS

Textured Charcoal Gray, Textured Putty



## PRODUCT HIGHLIGHTS

- **SECURE** – Lockable cabinet provides secure storage for sensitive supplies
- **NO ASSEMBLY** – Cabinets ship fully assembled
- **CAPACITY** – Secure Mini-Cabinets have 350-lb. weight capacity
- **MOUNTING** – Cabinets are wall-mountable
- **VARIETY** – Quick-View or Solid doors available. Colors include Textured Charcoal Gray, Textured Putty

## AkroDrawers®

Quick-View Mini-Cabinet 19 1/4" W x 13 1/4" D x 38" H			Dimensions (In.)			Qty. of Drawers
Model No.	Description	Cabinet Color	L	W	H	
ACQV4C ACQV4P	Secure Mini-Cabinet, Quick-View Door, no AkroDrawers	Textured Charcoal Gray Textured Putty	-	-	-	-
ACQV4C42 ACQV4P42	Secure Mini-Cabinet, Quick-View Door with 31142 AkroDrawers	Textured Charcoal Gray Textured Putty	11 1/2"	3 3/4"	4 1/2"	16
ACQV4C62 ACQV4P62	Secure Mini-Cabinet, Quick-View Door with 31162 AkroDrawers	Textured Charcoal Gray Textured Putty	11 1/2"	5 1/2"	4 1/2"	12
ACQV4C82 ACQV4P82	Secure Mini-Cabinet, Quick-View Door with 31182 AkroDrawers	Textured Charcoal Gray Textured Putty	11 1/2"	8 1/2"	4 1/2"	8
ACQV4CAST ACQV4PAST	Secure Mini-Cabinet, Quick-View Door with 31142, 31162 & 31182 AkroDrawers	Textured Charcoal Gray Textured Putty	See Above			4 / 6 / 2

Specify drawer color when ordering: Red, Blue, Yellow, Gray or Crystal Clear available with Gray Cabinet. Blue or Crystal Clear available with Putty Cabinet. One drawer color per unit.

Steel Door Mini-Cabinet 19 1/4" W x 13 1/4" D x 38" H			Dimensions (In.)			Qty. of Drawers
Model No.	Description	Cabinet Color	L	W	H	
ACS4C ACS4P	Secure Mini-Cabinet, Steel Door, no AkroDrawers	Textured Charcoal Gray Textured Putty	-	-	-	-
ACS4C42 ACS4P42	Secure Mini-Cabinet, Steel Door with 31142 AkroDrawers	Textured Charcoal Gray Textured Putty	11 1/2"	3 3/4"	4 1/2"	16
ACS4C62 ACS4P62	Secure Mini-Cabinet, Steel Door with 31162 AkroDrawers	Textured Charcoal Gray Textured Putty	11 1/2"	5 1/2"	4 1/2"	12
ACS4C82 ACS4P82	Secure Mini-Cabinet, Steel Door with 31182 AkroDrawers	Textured Charcoal Gray Textured Putty	11 1/2"	8 1/2"	4 1/2"	8
ACS4CAST ACS4PAST	Secure Mini-Cabinet, Steel Door with 31142, 31162 & 31182 AkroDrawers	Textured Charcoal Gray Textured Putty	See Above			4 / 6 / 2

Specify drawer color when ordering: Red, Blue, Yellow, Gray or Crystal Clear available with Gray Cabinet. Blue or Crystal Clear available with Putty Cabinet. One drawer color per unit.



# Stackable Cabinets

## STACKABLE DRAWER STORAGE CABINETS



UP TO  
120  
LBS.



AD3511C82, AD3517C68, AD3517BSC



AD3511C82R



AD3517P68CRY



AD3517BSC

### COLORS

Textured Charcoal Gray, Textured Putty



## FEATURES

- Stacking a 12" deep cabinet on top of an 18" cabinet provides additional work space
- For secure stacking, special feet nest into recessed dimples in the tops of the cabinets
- Optional base stands provide 8 more inches of height for easier, more comfortable access to lower shelves
- Durable powder-coated finish

## PRODUCT HIGHLIGHTS

- EFFICIENT** – Increased storage capacity for AkroDrawers® by providing more space to organize and color code inventory
- STACKABLE** – Units can be stacked up to 3 high
- NO ASSEMBLY** – Cabinets ship fully assembled
- CAPACITY** – Weight capacity: 120 lbs. Combined stacked weight capacity: 200 lbs.
- VARIETY** – 2 sizes and 2 colors: Textured Charcoal Gray, Textured Putty

## AkroDrawers®

Stackable Cabinet 35" W x 11" D x 22" H			Bin Dimensions (In.)			Shelf Dimensions (In.)			Qty. of Drawers
Model No.	Description	Cabinet Color	L	W	H	D	L	H	
AD3511C AD3511P	Stackable Cabinet with no AkroDrawers	Textured Charcoal Gray Textured Putty	-	-	-	11	34	4 1/8	-
AD3511CAST2 AD3511PAST2	Stackable Cabinet with 31112 & 31162 AkroDrawers	Textured Charcoal Gray Textured Putty	11%	11%*	4%	11	34	4 1/8	8 / 8
AD3511C62 AD3511P62	Stackable Cabinet with 31162 AkroDrawers	Textured Charcoal Gray Textured Putty	11%	5%	4%	11	34	4 1/8	24
AD3511C82 AD3511P82	Stackable Cabinet with 31182 AkroDrawers	Textured Charcoal Gray Textured Putty	11%	8%	4%	11	34	4 1/8	16

Specify drawer color when ordering: Red, Blue, Yellow, Gray or Crystal Clear available with Gray Cabinet. Blue or Crystal Clear available with Putty Cabinet. One drawer color per unit. \*Width of 31112 bin.

Stackable Cabinet 35" W x 17" D x 22" H			Bin Dimensions (In.)			Shelf Dimensions (In.)			Qty. of Drawers
Model No.	Description	Cabinet Color	L	W	H	D	L	H	
AD3517C AD3517P	Stackable Cabinet with no AkroDrawers	Textured Charcoal Gray Textured Putty	-	-	-	17	34	4 1/8	-
AD3517CAST2 AD3517PAST2	Stackable Cabinet with 31118 & 31168 AkroDrawers	Textured Charcoal Gray Textured Putty	17%	11%*	4%	17	34	4 1/8	8 / 8
AD3517C68 AD3517P68	Stackable Cabinet with 31168 AkroDrawers	Textured Charcoal Gray Textured Putty	17%	5%	4%	17	34	4 1/8	24
AD3517C88 AD3517P88	Stackable Cabinet with 31188 AkroDrawers	Textured Charcoal Gray Textured Putty	17%	8%	4%	17	34	4 1/8	16
AD3517CAST AD3517PAST	Stackable Cabinet with 31168 & 31188 AkroDrawers	Textured Charcoal Gray Textured Putty	See Above			17	34	4 1/8	12 / 8

Specify drawer color when ordering: Red, Blue, Yellow, Gray or Crystal Clear available with Gray Cabinet. Blue or Crystal Clear available with Putty Cabinet. One drawer color per unit. \*Width of 31118 bin.

Optional Base Stands for Stackable Cabinets			Dimensions (In.)		
Model No.	Description	Base Stand Color	W	D	H
AD3511BSC AD3511BSP	Base Stand for 11" Stackable Cabinet	Textured Charcoal Gray Textured Putty	35 1/4	11 1/4	8
AD3517BSC AD3517BSP	Base Stand for 17" Stackable Cabinet	Textured Charcoal Gray Textured Putty	35 1/4	17 1/4	8

# Super Modular Cabinets

STACKABLE OR WALL-MOUNTED DRAWER STORAGE CABINETS

800.253.2467  
akro-mils.com



## FEATURES

- 1 For secure stacking, special feet nest into recessed dimples in the tops of the cabinets
- 2 AkroDrawers® fit snugly on each shelf so drawer is protected from dust and debris
- 3 Durable powder-coated finish



AD1811CASTCRY



AD1811C62Y

AD1817P88B

AD2311C62R

## PRODUCT HIGHLIGHTS

- **FUNCTIONAL** – Specially designed stackable or wall-mountable cabinets to organize AkroDrawers
- **STACKABLE** – Units can be stacked up to 3 high
- **WALL-MOUNTABLE** – Light assembly required for mounting of 11" cabinets
- **VERSATILE** – 11" cabinets can be hung on louvered panels or rail racks (bracket included)
- **NO ASSEMBLY** – Cabinets ship fully assembled
- **CAPACITY** – Weight capacity: 60 lbs. (18" cabinets); 75 lbs. (23" cabinets). Combined stacked weight capacity: 100 lbs.
- **VARIETY** – 3 sizes and 2 colors: Textured Charcoal Gray, Textured Putty

## COLORS

Textured Charcoal Gray, Textured Putty

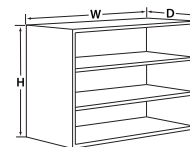

## AkroDrawers®

Super Modular Cabinets 18" W x 11" D x 16½" H			Bin Dimensions (In.)			Shelf Dimensions (In.)			
Model No.	Description	Cabinet Color	L	W	H	D	L	H	Qty. of Drawers
AD1811C AD1811P	Small Cabinet with no AkroDrawers	Textured Charcoal Gray Textured Putty	–	–	–	11	17	4½	–
AD1811C62 AD1811P62	Small Cabinet with 31162 AkroDrawers	Textured Charcoal Gray Textured Putty	11½	5½	4½	11	17	4½	9
AD1811C82 AD1811P82	Small Cabinet with 31182 AkroDrawers	Textured Charcoal Gray Textured Putty	11½	8	4½	11	17	4½	6
AD1811CAST AD1811PAST	Small Cabinet with 31162 and 31182 AkroDrawers	Textured Charcoal Gray Textured Putty	See Above			11	17	4½	6 / 2

Specify drawer color when ordering: Red, Blue, Yellow, Gray or Crystal Clear available with Gray Cabinet. Blue or Crystal Clear available with Putty Cabinet. One drawer color per unit.



Super Modular Cabinets 18" W x 17" D x 16½" H			Bin Dimensions (In.)			Shelf Dimensions (In.)			
Model No.	Description	Cabinet Color	L	W	H	D	L	H	Qty. of Drawers
AD1817C AD1817P	17" Deep Cabinet with no AkroDrawers	Textured Charcoal Gray Textured Putty	–	–	–	17	17	4½	–
AD1817C68 AD1817P68	17" Deep Cabinet with 31168 AkroDrawers	Textured Charcoal Gray Textured Putty	17½	5½	4½	17	17	4½	9
AD1817C88 AD1817P88	17" Deep Cabinet with 31188 AkroDrawers	Textured Charcoal Gray Textured Putty	17½	8	4½	17	17	4½	6
AD1817CAST AD1817PAST	17" Deep Cabinet with 31168 and 31188 AkroDrawers	Textured Charcoal Gray Textured Putty	See Above			17	17	4½	6 / 2

Specify drawer color when ordering: Red, Blue, Yellow, Gray or Crystal Clear available with Gray Cabinet. Blue or Crystal Clear available with Putty Cabinet. One drawer color per unit.



Super Modular Cabinets 23" W x 11" D x 16½" H			Bin Dimensions (In.)			Shelf Dimensions (In.)			
Model No.	Description	Cabinet Color	L	W	H	D	L	H	Qty. of Drawers
AD2311C AD2311P	Medium Cabinet with no AkroDrawers	Textured Charcoal Gray Textured Putty	–	–	–	11	22	4½	–
AD2311C62 AD2311P62	Medium Cabinet with 31162 AkroDrawers	Textured Charcoal Gray Textured Putty	11½	5½	4½	11	22	4½	12

Specify drawer color when ordering: Red, Blue, Yellow, Gray or Crystal Clear available with Gray Cabinet. Blue or Crystal Clear available with Putty Cabinet. One drawer color per unit.







# Wire Shelving Systems

MORE THAN 50 SYSTEM OPTIONS AVAILABLE

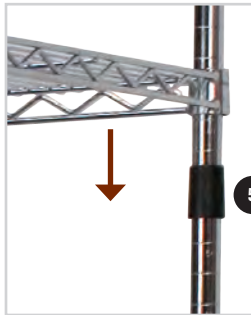

UP TO  
2000  
LBS.



## FEATURES

- 1 Open wire design minimizes dust accumulation and improves visibility for stored contents
- 2 Constructed from steel with a chrome finish
- 3 Lightweight yet strong metal framework secures shelving in place
- 4 Adjustable shelves
- 5 Quick-Adjust Clips lock onto shelf posts, and unlock to adjust shelves
- 6 Leveling bolts screw securely into uprights to level shelf system on uneven surfaces

## PRODUCT HIGHLIGHTS

- **EFFICIENT** – Streamlines workflow and order picking
- **FUNCTIONAL** – Works with a variety of Akro-Mils storage products to organize parts and increase efficiency
- **CAPACITY** – Stationary units hold a maximum of 2,000 lbs.; mobile units with casters have a capacity of 900 lbs. Maximum weight capacity per shelf: 48" or shorter = 800 lbs.; longer than 48" = 600 lbs.
- **ASSEMBLY** – Easy, one-person set-up and installation. No tools required!
- **VARIETY** – 6 shelf sizes available: 14" x 36", 18" x 36", 24" x 36", 18" x 48", 24" x 48", 24" x 60"

**COLOR**  
Chrome

Wire Shelf Components	
Model No.	Description
AWS1436SHELF	14" x 36" Chrome Wire Shelf
AWS1836SHELF	18" x 36" Chrome Wire Shelf
AWS1848SHELF	18" x 48" Chrome Wire Shelf
AWS2436SHELF	24" x 36" Chrome Wire Shelf
AWS2448SHELF	24" x 48" Chrome Wire Shelf
AWS2460SHELF	24" x 60" Chrome Wire Shelf
AWP74UPRIGHT	74" Chrome Upright
AWP63UPRIGHT	63" Chrome Upright
AWP63CASTER	5" Swivel Caster w/Brake for 63" Upright
AWP63CASTNB	5" Swivel Caster for 63" Upright
AWFOOTPLATE	Steel Feet Immobilizers

## Wire Shelving System Components

Create a custom system to provide a cleaner, more organized environment and reduce lost inventory.



### Shelves

Adjustable to hold a variety of Akro-Mils bins and containers



### Uprights

For standard and mobile options



### Quick-Adjust Clips

Unlock to adjust shelves



### Locking Casters

Highly maneuverable, locking wheels create mobile or stationary units



### Non-Locking Casters

Highly maneuverable, non-locking wheels create mobile units



### Footplates

Steel tips on bottom of frames prevent movement of stationary units



AWS184830260G



AWS184830280R



AWS143630120Y



AWS244837608G



AWS2460M34240

AkroBin Wire Systems			Bin Dimensions (In.)			Shelf Dimensions (In.)			Quantity	
Model No.	Description	AkroBin Colors	L	W	H	D	L	H	Bins	Shelves
AWS143630320	Wire Shelving w/ 30320 Bins	B, R, Y, G, S, BK, SC	8%	33	5	14	36	74	12	11
AWS143630240	Wire Shelving w/ 30240 Bins	B, R, Y, G, S, BK, SC	14%	8%	7	14	36	74	36	4
AWS143630250	Wire Shelving w/ 30250 Bins	B, R, Y, G, S, BK, SC	14%	16½	7	14	36	74	18	4
AWS184830260	Wire Shelving w/ 30260 Bins	B, R, Y, G, S, BK, SC	18	11	10	18	48	74	24‡	6
AWS183630265	Wire Shelving w/ 30265 Bins	B, R, Y, G, S, BK, SC	18	8¼	9	18	36	74	18‡	5
AWS183630270	Wire Shelving w/ 30270 Bins	B, R, Y, G, S, BK, SC	18	16½	11	18	36	74	9‡	5
AWS2460M30358	Mobile Wire Shelving w/ 30358 Bins	BEIGE	20½	11	7	24	60	68	30	6

Bin color code: R=Red, B=Blue, Y=Yellow, G=Green, S=Stone, BK=Black, SC=Clear. Specify one bin color when ordering. ‡Bonus bins included.

Super-Size AkroBin Wire Systems			Bin Dimensions (In.)			Shelf Dimensions (In.)			Quantity	
Model No.	Description	Super-Size AkroBin Colors	L	W	H	D	L	H	Bins	Shelves
AWS184830280	Wire Shelving w/ 30280 Bins	R, B, Y, SC	20	12%	6	18	48	74	24	9
AWS184830281	Wire Shelving w/ 30281 Bins	R, B, Y, SC	20	12%	8	18	48	74	18	7
AWS184830282	Wire Shelving w/ 30282 Bins	R, B, Y, SC	20	12%	12	18	48	74	12	5
AWS184830283	Wire Shelving w/ 30283 Bins	R, B, Y, SC	20	18	12	18	48	74	8	5
AWS18485AB	Wire Shelving w/ 30280, 281, 282, 283 Bins	R, B, Y, SC	See Above			18	48	74	4/3/4/4‡	6
AWS24360284	Wire Shelving w/ 30284 Bins	R, B, Y, SC	23%	8¼	7	24	36	74	28	8
AWS24360287	Wire Shelving w/ 30287 Bins	R, B, Y, SC	23%	11	10	24	36	74	16‡	6
AWS24360288	Wire Shelving w/ 30288 Bins	R, B, Y, SC	23%	16½	11	24	36	74	12	3
AWS243605AB	Wire Shelving w/ 30287 & 30288 Bins	R, B, Y, SC	See Above			24	36	74	12/6‡	3
AWS24361288	Wire Shelving w/ 30288 Bins	R, B, Y, SC	23%	16½	11	24	36	63	10	3

Bin color code: R=Red, B=Blue, Y=Yellow, SC=Clear. Specify one bin color when ordering. ‡Bonus bins included.

4" Shelf Bin Wire Systems			Bin Dimensions (In.)			Shelf Dimensions (In.)			Quantity	
Model No.	Description	Shelf Bin Colors	L	W	H	D	L	H	Bins	Shelves
AWS143630120	Wire Shelving w/ 30120 Bins	R, B, Y, G, W, SC	11%	4%	4	14	36	74	96	12
AWS143630130	Wire Shelving w/ 30130 Bins	R, B, Y, G, W, SC	11%	6%	4	14	36	74	60	12
AWS143630150	Wire Shelving w/ 30150 Bins	R, B, Y, G, W, SC	11%	8%	4	14	36	74	48	12
AWS143630170	Wire Shelving w/ 30170 Bins	R, B, Y, G, W, SC	11%	11%	4	14	36	74	36	12
AWS183630128	Wire Shelving w/ 30128 Bins	R, B, Y, G, W, SC	17%	4%	4	18	36	74	96	12
AWS183630138	Wire Shelving w/ 30138 Bins	R, B, Y, G, W, SC	17%	6%	4	18	36	74	60	12
AWS183630158	Wire Shelving w/ 30158 Bins	R, B, Y, G, W, SC	17%	8%	4	18	36	74	48	12
AWS183630178	Wire Shelving w/ 30178 Bins	R, B, Y, G, W, SC	17%	11%	4	18	36	74	36	12
AWS244830124	Wire Shelving w/ 30124 Bins	R, B, Y, G, W, SC	23%	4%	4	24	48	74	120	12
AWS244830164	Wire Shelving w/ 30164 Bins	R, B, Y, G, W, SC	23%	6%	4	24	48	74	66	12
AWS244830184	Wire Shelving w/ 30184 Bins	R, B, Y, G, W, SC	23%	8%	4	24	48	74	60‡	12
AWS244830174	Wire Shelving w/ 30174 Bins	R, B, Y, G, W, SC	23%	11%	4	24	48	74	48‡	12

Bin color code: R=Red, B=Blue, Y=Yellow, G=Green, W=White, SC=Clear. Specify one bin color when ordering. ‡Bonus bins included.

Straight Wall Container Wire Systems			Bin Dimensions (In.)			Shelf Dimensions (In.)			Quantity	
Model No.	Description	Container Colors	L	W	H	D	L	H	Bins	Shelves
AWS244837608	Wire Shelving w/ 37608 Containers	R, GRAY	23%	15%	8¼	24	48	74	12	6

Bin color code: R=Red, GRAY=Gray. Specify one bin color when ordering.

Akro-Tub Wire Systems			Bin Dimensions (In.)			Shelf Dimensions (In.)			Quantity	
Model No.	Description	Akro-Tub Colors	L	W	H	D	L	H	Bins	Shelves
AWS1836M34301	Mobile Wire Shelving w/ 34301 Tubs	GRY	17½	11	8	18	36	68	24‡	7
AWS2460M34240	Mobile Wire Shelving w/ 34240 Tubs	GRY	19	24½	9½	24	60	68	12	4

‡Bonus bins included.

# Wire Shelving Systems

## MORE THAN 50 SYSTEM OPTIONS AVAILABLE



AWS183613014B



AWS143630040R



AWS183630400W

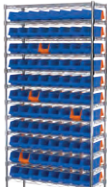

AWS143636442B



AWS183630318R



AWS246035225B



AWS183633168GRY

Stak-N-Store Wire Systems			Bin Dimensions (In.)			Shelf Dimensions (In.)			Quantity	
Model No.	Description	Stak-N-Store Bin Colors	L	W	H	D	L	H	# of Bins	Shelves
AWS184813017	Wire Shelving w/ 13017 Bins	GRY, R, B, W, SC	15½	19%	12¾	18	48	74	9	5
AWS183613014	Wire Shelving w/ 13014 Bins	GRY, R, B, SC	17½	10%	12½	18	36	74	12	5
AWS183613018	Wire Shelving w/ 13018 Bins	GRY, R, B, SC	17½	16½	12½	18	36	74	8	5
AWS1836SNS	Wire Shelving w/ 13014 & 13018 Bins	GRY, R, B, SC	See Above			18	36	74	8 / 6 ‡	5

Bin color code: R=Red, B=Blue, W=White, GRY=Gray, SC=Clear. Specify one bin color when ordering. ‡Bonus bins included.

6" ShelfMax Wire Systems			Bin Dimensions (In.)			Shelf Dimensions (In.)			Quantity	
Model No.	Description	ShelfMax Bin Colors	L	W	H	D	L	H	# of Bins	Shelves
AWS143630040	Wire Shelving w/ 30040	R, B, Y, G, W, SC	11%	4%	6	14	36	74	64	9
AWS143630080	Wire Shelving w/ 30080	R, B, Y, G, W, SC	11%	8%	6	14	36	74	32	9
AWS143630090	Wire Shelving w/ 30090	R, B, Y, G, W, SC	11%	6%	6	14	36	74	40	9
AWS183630048	Wire Shelving w/ 30048	R, B, Y, G, W, SC	17%	4%	6	18	36	74	64	9
AWS183630098	Wire Shelving w/ 30098	R, B, Y, G, W, SC	17%	6%	6	18	36	74	40	9
AWS183630088	Wire Shelving w/ 30088	R, B, Y, G, W, SC	17%	8%	6	18	36	74	32	9
AWS243630094	Wire Shelving w/ 30094	R, B, Y, G, W, SC	23%	6%	6	24	36	74	40	9

Bin color code: R=Red, B=Blue, Y=Yellow, G=Green, W=White, SC=Clear. Specify one bin color when ordering.

VantageBin Wire Systems			Bin Dimensions (In.)			Shelf Dimensions (In.)			Quantity	
Model No.	Description	VantageBin Colors	L	W	H	D	L	H	# of Bins	Shelves
AWS183630400	Wire Shelving w/ 30400 Bins	GRY, Y, W	16¾	7¼	5¾	18	36	74	40	11
AWS244830420	Wire Shelving w/ 30420 Bins	GRY, W	24	5½	7	24	48	74	42 ‡	6

Bin color code: Y=Yellow, W=White, GRY=Gray. Specify one bin color when ordering. ‡Bonus bins included.

Indicator Wire Systems			Bin Dimensions (In.)			Shelf Dimensions (In.)			Quantity	
Model No.	Description	Indicator Colors	L	W	H	D	L	H	# of Bins	Shelves
AWS143636442B	Wire Shelving w/ 36442 Indicator Bins	Blue/Orange	11%	4%	4	14	36	74	96*	12
AWS143636462B	Wire Shelving w/ 36462 Indicator Bins	Blue/Orange	11%	6%	4	14	36	74	60*	12
AWS183636448B	Wire Shelving w/ 36448 Indicator Bins	Blue/Orange	17%	4%	4	18	36	74	96*	12
AWS183636468B	Wire Shelving w/ 36468 Indicator Bins	Blue/Orange	17%	6%	4	18	36	74	60*	12

\*Bonus Bins Included.

System Bin Wire Systems			Bin Dimensions (In.)			Shelf Dimensions (In.)			Quantity	
Model No.	Description	System Bin Colors	L	W	H	D	L	H	# of Bins	Shelves
AWS143630312	Wire Shelving w/ 30312 Bins	R, Y, B	33	12	5	14	36	74	10	11
AWS183630318	Wire Shelving w/ 30318 Bins	R, Y, B	33	18	5	18	36	74	10	11

Bin color code: R=Red, B=Blue, Y=Yellow. Specify one bin color when ordering.

Nest & Stack Wire Systems			Bin Dimensions (In.)			Shelf Dimensions (In.)			Quantity	
Model No.	Description	Nest & Stack Tote Colors	L	W	H	D	L	H	# of Bins	Shelves
AWS183635180	Wire Shelving w/ 35180 Totes	B, R, GRY	18	11	6	18	36	74	30 ‡	9
AWS246035225	Wire Shelving w/ 35225 Totes	B, R, GRY	23½	19½	10	24	60	74	12	4

Lids sold separately. Bin color code: R=Red, B=Blue, GRY=Gray. Specify one bin color when ordering. ‡Bonus bins included.

Akro-Grid Wire Systems			Bin Dimensions (In.)			Shelf Dimensions (In.)			Quantity	
Model No.	Description	Akro-Grid Tote Colors	L	W	H	D	L	H	# of Bins	Shelves
AWS183633166	Wire Shelving w/ 33166 Grids	B, R, GRY	16½	10%	6	18	36	74	24	9
AWS183633168	Wire Shelving w/ 33168 Grids	B, R, GRY	16½	10%	8	18	36	74	18	7
AWS2460M33224	Mobile Wire Shelving w/ 33224 Grids	B, R, GRY	22¾	17%	4	24	60	68	36	12

Bin color code: R=Red, B=Blue, GRY=Gray. Specify one bin color when ordering. Dividers sold separately.





# Steel Shelving Systems

MORE THAN 40 SYSTEM OPTIONS AVAILABLE

800.253.2467  
akro-mils.com



UP TO  
**6500**  
LBS.

## FEATURES

- 1 Manufactured from high-grade, 22-gauge steel
- 2 Powder-coated finish
- 3 Quickly change shelf heights with compression clips
- 4 Adjustable shelves

## PRODUCT HIGHLIGHTS

- **EFFICIENT** – Can be ordered independently or purchased with bins for a complete system
- **FUNCTIONAL** – Efficiently organize large, heavy items and improve workflow
- **VARIETY** – 5 shelf sizes available: 12" x 36", 18" x 36", 18" x 42", 24" x 36", 30" x 36"
- **CAPACITY** – Shelving units have 355 to 600 lb. weight capacity per shelf when assembled and installed per instructions. Per shelf weight capacity: 12" x 36": 500 lbs.; 18" x 36": 550 lbs.; 18" x 42": 355 lbs.; 24" x 36": 550 lbs.; 30" x 36": 600 lbs.

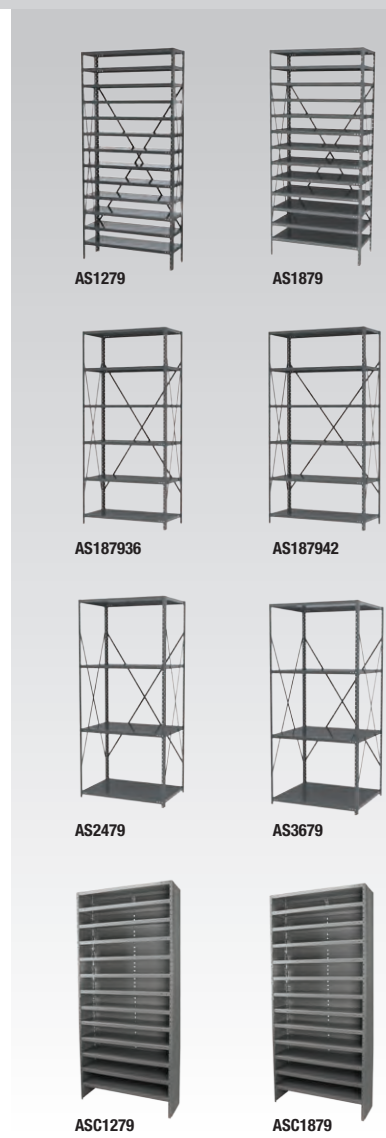

COLOR  
Gray



Steel Shelving		Shelf Dimensions (In.)			Quantity
Model Number	Description	D	L	H	Shelves
ASC1279	12" Enclosed Shelving (no AkroDrawers)	12	36	79	13
ASC1879	18" Enclosed Shelving (no AkroDrawers)	18	36	79	13
AS1279	12" Shelving (no Bins)	12	36	79	13
AS1879	18" Shelving (no Bins)	18	36	79	13
AS2479	24" Shelving (no Bins)	24	36	79	4
AS3679	30" Shelving (no Bins)	30	36	79	4
AS187936	36" Shelving (no Bins)	18	36	79	6
AS187942	42" Shelving (no Bins)	18	42	79	6



# Steel Shelving Systems

MORE THAN 40 SYSTEM OPTIONS AVAILABLE



ASC1279112B

12" Enclosed Shelving Systems			Bin Dimensions (In.)			Shelf Dimensions (In.)			Quantity	
Model Number	Description	AkroDrawer Colors	L	W	H	D	L	H	Drawers	Shelves
ASC1279112	Shelving with 31112 AkroDrawers	R, Y, B, GRY, CRY	11%	11%	4%	12	36	79	36	13
ASC1279142	Shelving with 31142 AkroDrawers	R, Y, B, GRY, CRY	11%	3%	4%	12	36	79	108	13
ASC1279162	Shelving with 31162 AkroDrawers	R, Y, B, GRY, CRY	11%	5%	4%	12	36	79	72	13
ASC1279182	Shelving with 31182 AkroDrawers	R, Y, B, GRY, CRY	11%	8%	4%	12	36	79	48	13
ASC1279A5T	Shelving with 31142, 31162, 31182 AkroDrawers	R, Y, B, GRY, CRY	See Above			12	36	79	30 / 36 / 12 ‡	13

Drawer color code: R=Red, B=Blue, Y=Yellow, GRY=Gray, CRY=Clear. Specify drawer color when ordering. Only one color per unit. ‡Bonus drawers included.

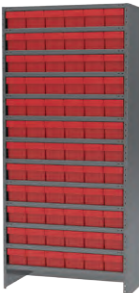
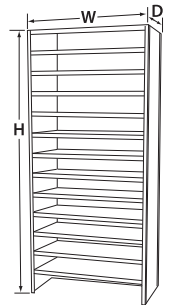

ASC1879168R

18" Enclosed Shelving Systems			Bin Dimensions (In.)			Shelf Dimensions (In.)			Quantity	
Model Number	Description	AkroDrawer Colors	L	W	H	D	L	H	Drawers	Shelves
ASC1879118	Shelving with 31118 AkroDrawers	R, Y, B, GRY, CRY	17%	11%	4%	18	36	79	36	13
ASC1879148	Shelving with 31148 AkroDrawers	R, Y, B, GRY, CRY	17%	3%	4%	18	36	79	108	13
ASC1879168	Shelving with 31168 AkroDrawers	R, Y, B, GRY, CRY	17%	5%	4%	18	36	79	72	13
ASC1879188	Shelving with 31188 AkroDrawers	R, Y, B, GRY, CRY	17%	8%	4%	18	36	79	48	13
ASC1879A5T	Shelving with 31168, 31188 AkroDrawers	R, Y, B, GRY, CRY	See Above			18	36	79	36 / 24	13

Drawer color code: R=Red, B=Blue, Y=Yellow, GRY=Gray, CRY=Clear. Specify drawer color when ordering. Only one color per unit.

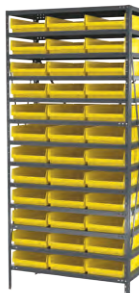

AS1879178Y

Shelf Bin Shelving Systems			Bin Dimensions (In.)			Shelf Dimensions (In.)			Quantity	
Model Number	Description	Shelf Bin Colors	L	W	H	D	L	H	Bins	Shelves
AS1279110	12" Shelving with 30110 Bins	R, B, Y, G, W, SC	11%	2%	4	12	36	79	144	13
AS1279120	12" Shelving with 30120 Bins	R, B, Y, G, W, SC	11%	4%	4	12	36	79	96	13
AS1279130	12" Shelving with 30130 Bins	R, B, Y, G, W, SC	11%	6%	4	12	36	79	60	13
AS1279150	12" Shelving with 30150 Bins	R, B, Y, G, W, SC	11%	8%	4	12	36	79	48	13
AS1279170	12" Shelving with 30170 Bins	R, B, Y, G, W, SC	11%	11%	4	12	36	79	36	13
AS1879128	18" Shelving with 30128 Bins	R, B, Y, G, W, SC	17%	4%	4	18	36	79	96	13
AS1879138	18" Shelving with 30138 Bins	R, B, Y, G, W, SC	17%	6%	4	18	36	79	60	13
AS1879158	18" Shelving with 30158 Bins	R, B, Y, G, W, SC	17%	8%	4	18	36	79	48	13
AS1879178	18" Shelving with 30178 Bins	R, B, Y, G, W, SC	17%	11%	4	18	36	79	36	13

Bin color code: R=Red, B=Blue, Y=Yellow, G=Green, W=White, SC=Clear. Specify one bin color when ordering.



AS2479094G

ShelfMax Shelving Systems			Bin Dimensions (In.)			Shelf Dimensions (In.)			Quantity	
Model Number	Description	ShelfMax Bin Color	L	W	H	D	L	H	Bins	Shelves
AS1279040	12" Steel Shelving with 30040 Bins	R, B, Y, G, W, SC	11%	4%	6	12	36	79	80	11
AS1279080	12" Steel Shelving with 30080 Bins	R, B, Y, G, W, SC	11%	8%	6	12	36	79	40	11
AS1279090	12" Steel Shelving with 30090 Bins	R, B, Y, G, W, SC	11%	6%	6	12	36	79	50	11
AS1879048	18" Steel Shelving with 30048 Bins	R, B, Y, G, W, SC	17%	4%	6	18	36	79	80	11
AS1879088	18" Steel Shelving with 30088 Bins	R, B, Y, G, W, SC	17%	8%	6	18	36	79	40	11
AS1879098	18" Steel Shelving with 30098 Bins	R, B, Y, G, W, SC	17%	6%	6	18	36	79	50	11
AS2479094	24" Steel Shelving with 30094 Bins	R, B, Y, G, W, SC	23%	6%	6	24	36	79	50	11

Bin color code: R=Red, B=Blue, Y=Yellow, G=Green, W=White, SC=Clear. Specify one bin color when ordering.



AS3679293R

Super-Size AkroBin Shelving Systems			Bin Dimensions (In.)			Shelf Dimensions (In.)			Quantity	
Model Number	Description	Super-Size AkroBin Color	L	W	H	D	L	H	Bins	Shelves
AS2479284	24" Shelving with 30284 Bins	B, R, Y, SC	23 $\frac{3}{8}$ "	8 $\frac{1}{4}$ "	7"	24"	36"	79"	32 $\frac{1}{2}$	9
AS2479287	24" Shelving with 30287 Bins	B, R, Y, SC	23 $\frac{3}{8}$ "	11"	10"	24"	36"	79"	24 $\frac{1}{2}$	3
AS2479288	24" Shelving with 30288 Bins	B, R, Y, SC	23 $\frac{3}{8}$ "	16 $\frac{1}{2}$ "	11"	24"	36"	79"	12	4
AS2479ASSORT	24" Shelving with 30287/30288 Bins	B, R, Y, SC	See Above			24"	36"	79"	12/6	3
AS3679292	30" Shelving with 30292 Bins	B, R, Y, SC	29 $\frac{1}{8}$ "	11"	10"	30"	36"	79"	24	3
AS3679293	30" Shelving with 30293 Bins	B, R, Y, SC	29 $\frac{1}{8}$ "	16 $\frac{1}{2}$ "	11"	30"	36"	79"	12	4
AS3679ASSORT	30" Shelving with 30292/30293 Bins	B, R, Y, SC	See Above			30"	36"	79"	12/6	3

Bin color code: R=Red, B=Blue, Y=Yellow, SC=Clear. Specify one bin color when ordering. †Bonus bins included.

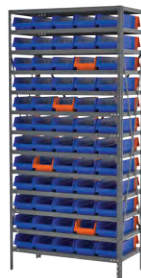

AS127936468B

Indicator Bin Shelving Systems			Bin Dimensions (In.)			Shelf Dimensions (In.)			Quantity	
Model Number	Description	Indicator Colors	L	W	H	D	L	H	Bins	Shelves
AS127936442B	Shelving, with 36442BLUE Indicator Bins	Blue/Orange	11 $\frac{1}{8}$ "	4 $\frac{1}{4}$ "	4"	12"	36"	79"	96	13
AS127936462B	Shelving, with 36462BLUE Indicator Bins	Blue/Orange	11 $\frac{1}{8}$ "	6 $\frac{3}{4}$ "	4"	12"	36"	79"	60	13
AS187936448B	Shelving, with 36448BLUE Indicator Bins	Blue/Orange	17 $\frac{7}{8}$ "	4 $\frac{1}{4}$ "	4"	18"	36"	79"	96	13
AS187936468B	Shelving, with 36468BLUE Indicator Bins	Blue/Orange	17 $\frac{7}{8}$ "	6 $\frac{5}{8}$ "	4"	18"	36"	79"	60	13



AS1879318Y

System Bin Shelving Systems			Bin Dimensions (In.)			Shelf Dimensions (In.)			Quantity	
Model Number	Description	Bin Color	L	W	H	D	L	H	Bins	Shelves
AS1279312	12" Shelving with System Bins	B, R, Y	33"	12"	5"	12"	36"	79"	10	11
AS1879318	18" Shelving with System Bins	B, R, Y	33"	18"	5"	18"	36"	79"	10	11



AS1879ASORTR

Stak-N-Store Shelving Systems			Bin Dimensions (In.)			Shelf Dimensions (In.)			Quantity	
Model Number	Description	Stak-N-Store Color	L	W	H	D	L	H	Bins	Shelves
AS187913014	36" Shelving, with 13014 Bins	B, R, GRY, SC	17 $\frac{1}{2}$ "	10 $\frac{1}{8}$ "	12 $\frac{1}{2}$ "	18"	36"	79"	16 $\frac{1}{2}$	6
AS187913018	36" Shelving, with 13018 Bins	B, R, GRY, SC	17 $\frac{1}{2}$ "	16 $\frac{1}{2}$ "	12 $\frac{1}{2}$ "	18"	36"	79"	10	6
AS1879ASORT	36" Shelving, with 13014, 13018 Bins	B, R, GRY, SC	See Above			18"	36"	79"	8/6 $\frac{1}{2}$	6
AS187913017	42" Shelving, with 13017 Bins	B, R, GRY, SC, W	15 $\frac{1}{4}$ "	19 $\frac{1}{8}$ "	12 $\frac{1}{16}$ "	18"	42"	79"	12 $\frac{1}{2}$	6

Bin color code: R=Red, B=Blue, W=White, GRY=Gray, SC=Clear. Specify one bin color when ordering. †Bonus bins included.





# VERSA/Deck™

VERSATILE STRUCTURAL FOAM PLATFORM TRUCK



## FEATURES

- 1 Sturdy, easy-to-clean non-skid structural foam deck resists most chemicals and damage from long-term weather exposure
- 2 Steel reinforcements run lengthwise under the deck
- 3 6 handle/rail configurations
- 4 Multiple caster options available
- 5 Durable, powder-coated finish



## PRODUCT HIGHLIGHTS

- **DURABLE** – HDPE molded structural foam. VERSA/Decks feature steel reinforcement
- **CAPACITY** – Caster options allow up to 3,000 lb. weight capacity
- **VARIETY** – Multiple handle, deck and caster options to select the exact configuration you need. Decks come in 2 sizes: 24" x 48" and 30" x 60"

COLOR  
Black/Gray



**CASTER & WHEEL CHOICES**  
allow you to resolve problems of noise control, floor protection, impact or abrasion resistance, or load capacity. See page 71 for more information.



Mold-On Rubber



Pneumatic



Polyolefin



Polyurethane



Thermo-Plastic



Handle Style "A"  
1 Crossbar Swayback  
or  
1 Open Swayback

Models ending in "11"  
have open handles,  
those ending in "12"  
have crossbar handles

Style "A"			
Model No.	Deck Size	Caster Type	Caster Size (In.)
R90110A1411	24 x 48	Pneumatic	10
R90110A1412	24 x 48	Pneumatic	10
R90162A1411	24 x 48	Polyolefin	6
R90162A1412	24 x 48	Polyolefin	6
R90163A1411	24 x 48	Polyurethane	6
R90163A1412	24 x 48	Polyurethane	6
R90181A1412	24 x 48	Pneumatic	8
R90181A1411	24 x 48	Pneumatic	8
R90182A1412	24 x 48	Mold-On Rubber	8
R90182A1411	24 x 48	Mold-On Rubber	8
R90184A1412	24 x 48	Polyolefin	8
R90184A1411	24 x 48	Polyolefin	8
R90185A1411	24 x 48	Thermo-Plastic	8
R90185A1412	24 x 48	Thermo-Plastic	8
R90210A1011	30 x 60	Pneumatic	10
R90210A1012	30 x 60	Pneumatic	10
R90262A1011	30 x 60	Polyolefin	6
R90262A1012	30 x 60	Polyolefin	6
R90263A1011	30 x 60	Polyurethane	6
R90263A1012	30 x 60	Polyurethane	6
R90281A1012	30 x 60	Pneumatic	8
R90281A1011	30 x 60	Pneumatic	8
R90282A1011	30 x 60	Mold-On Rubber	8
R90282A1012	30 x 60	Mold-On Rubber	8
R90284A1012	30 x 60	Polyolefin	8
R90284A1011	30 x 60	Polyolefin	8
R90285A1011	30 x 60	Thermo-Plastic	8
R90285A1012	30 x 60	Thermo-Plastic	8

Note: Models ending in "11" have open handles, those ending in "12" have crossbar handles.



Handle Style "D"  
3 Crossbar Straight Indeck

Style "D"			
Model No.	Deck Size	Caster Type	Caster Size (In.)
R90162D3817	24 x 48	Polyolefin	6
R90163D3817	24 x 48	Polyurethane	6
R90181D3817	24 x 48	Pneumatic	8
R90182D3817	24 x 48	Mold-On Rubber	8
R90262D3017	30 x 60	Polyolefin	6
R90263D3017	30 x 60	Polyurethane	6
R90281D3017	30 x 60	Pneumatic	8
R90282D3017	30 x 60	Mold-On Rubber	8



Handle Style "G"  
2 Crossbar Straight Indeck;  
1 Open Swayback

Style "G"			
Model No.	Deck Size	Caster Type	Caster Size (In.)
R90110G14112817	24 x 48	Pneumatic	10
R90181G14112817	24 x 48	Pneumatic	8
R90182G14112817	24 x 48	Mold-On Rubber	8
R90184G14112817	24 x 48	Polyolefin	8
R90210G10112017	30 x 60	Pneumatic	10
R90281G10112017	30 x 60	Pneumatic	8
R90282G10112017	30 x 60	Mold-On Rubber	8
R90284G10112017	30 x 60	Polyolefin	8



Handle Style "H"  
1 Crossbar Straight Indeck;  
2 Crossbar Swayback

Style "H"			
Model No.	Deck Size	Caster Type	Caster Size (In.)
R90162H24121817	24 x 48	Polyolefin	6
R90163H24121817	24 x 48	Polyurethane	6
R90181H24121817	24 x 48	Pneumatic	8
R90182H24121817	24 x 48	Mold-On Rubber	8
R90262H20121017	30 x 60	Polyolefin	6
R90263H20121017	30 x 60	Polyurethane	6
R90281H20121017	30 x 60	Pneumatic	8
R90282H20121017	30 x 60	Mold-On Rubber	8



Handle Style "B"  
2 Crossbar Swayback

Style "B"			
Model No.	Deck Size	Caster Type	Caster Size (In.)
R90110B2412	24 x 48	Pneumatic	10
R90181B2412	24 x 48	Pneumatic	8
R90182B2412	24 x 48	Mold-On Rubber	8
R90184B2412	24 x 48	Polyolefin	8
R90210B2012	30 x 60	Pneumatic	10
R90281B2012	30 x 60	Pneumatic	8
R90282B2012	30 x 60	Mold-On Rubber	8
R90284B2012	30 x 60	Polyolefin	8



Handle Style "L"  
2 Crossbar Straight Indeck;  
2 Open Swayback

Style "L"			
Model No.	Deck Size	Caster Type	Caster Size (In.)
R90110L24112817	24 x 48	Pneumatic	10
R90163L24112817	24 x 48	Polyurethane	6
R90181L24112817	24 x 48	Pneumatic	8
R90182L24112817	24 x 48	Mold-On Rubber	8
R90184L24112817	24 x 48	Polyolefin	8
R90210L20112017	30 x 60	Pneumatic	10
R90263L20112017	30 x 60	Polyurethane	6
R90281L20112017	30 x 60	Pneumatic	8
R90282L20112017	30 x 60	Mold-On Rubber	8
R90284L20112017	30 x 60	Polyolefin	8

Handle – Outside Deck



Open Style / Swayback



Crossbar / Swayback

Handle Rails – Indeck

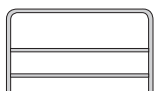

Crossbar / Straight



# Platform Trucks Wood Deck

FEATURING KILN-DRIED TONGUE & GROOVE HARDWOOD DECKS

## How to Order Your Wood Platform Truck



### STEP 1

#### PICK A DECK SIZE

All decks are 4/4 (7/8" thick) hardwood with tongue and groove construction.

**Standard deck sizes:**

24" x 48" • 27" x 54" • 30" x 60" • 36" x 72"

### STEP 2

#### PICK A DECK STYLE (1-2)

##### Series 1 – All Wood

- Standard with removable crossbar pipe handle at swivel end

##### Series 2 – Wood Deck with Steel Frame

- 2" x 2" x 1/8" all-welded steel angle frame keeps cart square (on 36" x 72" deck, 2" x 2" x 3/16")
- Heavy-duty steel frame for additional deck support
- Standard with removable crossbar pipe handle at swivel end
- The wood deck is reinforced with longitudinal stiffeners for maximum capacity. (See caster options for capacity)

### STEP 3

#### PICK SUPERSTRUCTURE (A-D)

##### Superstructure

Open pipe handle

Crossbar pipe handle

**COLOR**

Red

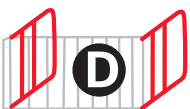
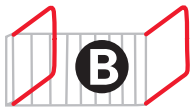
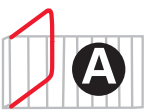

Crossbar handles are removable

### STEP 4

#### PICK RUNNING GEARS (4-7)

Rigid caster

Swivel caster

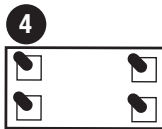

Four Swivel

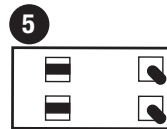

Two Rigid  
Two Swivel

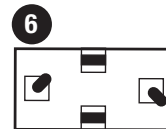

Tilt

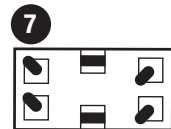

Tilt Quad

### STEP 5

#### PICK CASTER TYPE (P, M, Y, N, R, S)

Heavy-duty casters are bolted on for easy replacement. Caster options allow 1,180 to 3,000 lb. capacities.



Polyolefin  
5 x 2 • 6 x 2



Mold-On Rubber  
5 x 2 • 6 x 2 • 8 x 2



Polyurethane  
6 x 2 • 8 x 2



Pneumatic  
8 x 3 • 10 x 3 1/2



Non-Marking  
Rubber  
6 x 2 • 8 x 2



Steel  
8 x 2

Caster & Wheel choices allow you to resolve problems of noise control, floor protection, impact or abrasion resistance, or load capacity. See page 71 for more caster and wheel information.

### STEP 6

#### PICK CASTER SIZE – 5", 6", 8", 10"

Call your Akro-Mils distributor with your model number today to order

model #	step 1	step 2	step 3	step 4	step 5	step 6
Platform Truck	Size	Series	Super-structure	Running Gear Type	Caster Wheel	Caster Wheel Diameter
RPT	2448 2754 3060 3672	1 2	A B C D	4 5 6 7	P M Y N R S	5 6 8 10
RPT	3060	2	A	5	P	6

= RPT30602A5P6

**Ships fully assembled & ready to use!**







# Platform Trucks : Steel, Super-Heavy-Duty

ADDITIONAL HEAVY-DUTY TRUCK OPTIONS

800.253.2467  
akro-mils.com

PLATFORM TRUCKS

## Platform Trucks – Steel Deck

### FEATURES

- 1 Durable powder-coated finish
- 2 Smooth 13-gauge steel deck and frame
- 3 Steel reinforcements run lengthwise under the deck
- 4 Heavy-duty industrial casters (standard 2 swivel, 2 rigid) bolt-on for easy replacement
- 5 Removable crossbar handle

### PRODUCT HIGHLIGHTS

- **HEAVY-DUTY** – 13-gauge steel deck with longitudinal steel underdeck reinforcements
- **CAPACITY** – Caster options allow 800 to 2,000 lb. capacities
- **NO ASSEMBLY** – Trucks are shipped assembled and ready to use
- **VARIETY** – Special order platform trucks are available. Select from 8 standard deck sizes and a wide variety of handle and caster options
- **DECK SIZES** – 24" x 36", 24" x 48", 24" x 60", 27" x 54", 30" x 48", 30" x 60", 36" x 60", 36" x 72"



COLOR  
Gray



#### Platform Trucks - Steel

Model No.	Caster Type*	Caster Size (In.)	Weight Capacity (lbs.)	Deck Height (In.)
R2108FPB	Full Pneumatic	8 x 2	1200	11½
R2125MRB	Mold-On Rubber	5 x 2	1200	8
R2168MRB	Mold-On Rubber	8 x 2	2000	11

\*See page 71 for full description of casters and wheels.

## Platform Trucks – Super-Heavy-Duty

### FEATURES

- 1 Powder-coated steel frame
- 2 Super-heavy-duty kiln-dried hardwood deck
- 3 Steel C-channel and removable side rails allow for deck repair/replacement
- 4 High deck for minimal bending
- 5 Load wheels on solid 1" steel axle
- 6 Removable crossbar handle



COLOR  
Gray



#### Platform Trucks - Super-Heavy-Duty

Model No.	Caster Type*	Caster/Wheel Size (In.)	Weight Capacity (lbs.)	Deck Height (In.)
R2178MRB	Mold-On Rubber	8 x 2	2000	12¼
R219885MRB	Mold-On Rubber	8 x 2 / 8 x 2½	2500	12½
R221812MRB	Mold-On Rubber	8 x 2 / 12 x 2½	3000	16
R2258516MRB	Mold-On Rubber	8 x 2½ / 16 x 3	4000	19½

\*See page 71 for full description of casters and wheels.

### ACCESSORIES



Floor Locks



Wheel Locks



Corner Bumpers



Continuous Bumpers

### PRODUCT HIGHLIGHTS

- **HEAVY-DUTY** – Caster options allow 1,200 to 4,000 lb. capacities
- **NO ASSEMBLY** – Trucks are shipped completely assembled and ready to use
- **VARIETY** – Deck sizes: 24" x 48", 30" x 48", 30" x 60", 36" x 72"



# Platform Trucks Work Height – Heavy-Duty

TUBULAR FRAME SUPPORTS HEAVIER LOADS



## FEATURES

- 1 1½" 16-gauge tubular all-welded frame
- 2 Durable powder-coated finish
- 3 Deck options: kiln-dried tongue and groove hardwood, steel, structural foam
- 4 Fixed or adjustable height deck
- 5 Optional expanded metal or solid steel shelf



RWHV24481A5M8A



RWHS30601A5M8



RWH30601A5M8

COLOR  
Red



## PRODUCT HIGHLIGHTS

- **ERGONOMIC** – Height reduces strain of lifting and bending
- **DURABLE** – Hardwood, steel or structural foam decks available
- **CAPACITY** – Up to 2,000 lb. weight capacity
- **VARIETY** – Fixed and adjustable heights available. Optional expanded metal shelf or solid steel lower shelf. Deck sizes: 24" x 48", 30" x 60"

## ACCESSORIES



Corner Bumpers



Expanded Metal Shelf



Solid Metal Shelf

Platform Trucks - Fixed Work Height - Tubular Steel Frame		Dimensions (In.)			Caster		
Model No.	Deck Type	L	W	H	Type*	Size (In.)	Weight Capacity (lbs.)
RWH24481A5M8	Wood	24	48	26%	Mold-On Rubber	8	1800
RWHV24481A5M8	Structural Foam	24	48	26%	Mold-On Rubber	8	1800
RWHV24481A5Y6	Structural Foam	24	48	24%	Polyurethane	6	2000
RWHS24481A5M8	Steel	24	48	25%	Mold-On Rubber	8	1800
RWHS24481A5Y6	Steel	24	48	23¼	Polyurethane	6	1800
RWH30601A5M8	Wood	30	60	26%	Mold-On Rubber	8	1800
RWHV30601A5M8	Structural Foam	30	60	26%	Mold-On Rubber	8	1800
RWHV30601A5Y6	Structural Foam	30	60	24%	Polyurethane	6	2000
RWHS30601A5M8	Steel	30	60	25%	Mold-On Rubber	8	1800
RWHS30601A5Y6	Steel	30	60	23¼	Polyurethane	6	1800

\* See page 71 for full description of casters and wheels.

Platform Trucks - Adjustable Work Height - Tubular Steel Frame		Dimensions (In.)			Caster		
Model No.	Deck Type	L	W	H	Type*	Size (In.)	Weight Capacity (lbs.)
RWH24481A5M8A	Wood	24	48	26% to 32%	Mold-On Rubber	8	1800
RWHV24481A5M8A	Structural Foam	24	48	27½ to 33½	Mold-On Rubber	8	1800
RWHV24481A5Y6A	Structural Foam	24	48	25% to 31½	Polyurethane	6	2000
RWHS24481A5M8A	Steel	24	48	25% to 32	Mold-On Rubber	8	1800
RWHS24481A5Y6A	Steel	24	48	23% to 32	Polyurethane	6	1800
RWH30601A5M8A	Wood	30	60	26% to 32%	Mold-On Rubber	8	1800
RWHV30601A5M8A	Structural Foam	30	60	27½ to 33½	Mold-On Rubber	8	1800
RWHV30601A5Y6A	Structural Foam	30	60	25% to 31½	Polyurethane	6	2000
RWHS30601A5M8A	Steel	30	60	25% to 32	Mold-On Rubber	8	1800
RWHS30601A5Y6A	Steel	30	60	23% to 32	Polyurethane	6	1800

\* See page 71 for full description of casters and wheels.

# Platform Trucks Work Height – Standard-Duty : Skids

MORE STORAGE AND TRANSPORT OPTIONS

800.253.2467  
akro-mils.com

## Platform Trucks Work Height

STANDARD DUTY

### FEATURES

- 1 1½" x 1½" x 1/8" all-welded angle iron frame
- 2 Durable powder-coated finish
- 3 Deck options: kiln-dried tongue and groove hardwood, steel, structural foam
- 4 Fixed or adjustable height deck
- 5 Optional expanded metal or solid steel shelf



### PRODUCT HIGHLIGHTS

- **ERGONOMIC** – Height reduces strain of lifting and bending
- **VARIETY** – Fixed and adjustable heights available. Optional expanded metal shelf. Deck sizes: 24" x 48", 30" x 60"

COLOR  
Red



### ACCESSORIES



Expanded Metal Shelf



Solid Metal Shelf

Platform Trucks - Fixed Work Height - Angle Iron Frame		Dimensions (In.)			Caster		
Model No.	Deck Type	L	W	H	Type*	Size* (Inches)	Weight Capacity (lbs.)
RWH2448EA5M6	Wood	24	48	24½	Mold-On Rubber	6	1500
RWHV2448EA5M6	Structural Foam	24	48	24½	Mold-On Rubber	6	1500
RWHS2448EA5M6	All-Steel	24	48	22	Mold-On Rubber	6	1500
RWH3060EA5M6	Wood	30	60	24½	Mold-On Rubber	6	1500
RWHV3060EA5M6	Structural Foam	30	60	24½	Mold-On Rubber	6	1500
RWHS3060EA5M6	All-Steel	30	60	22	Mold-On Rubber	6	1500

\* See page 71 for full description of casters and wheels.

Platform Trucks - Adjustable Work Height - Angle Iron Frame		Dimensions (In.)			Caster		
Model No.	Deck Type	L	W	H	Type*	Size* (Inches)	Wt. Capacity (lbs.)
RWH2448EA5M6A	Wood	24	48	24½ to 30½	Mold-On Rubber	6	1500
RWHV2448EA5M6A	Structural Foam	24	48	24½ to 30½	Mold-On Rubber	6	1500
RWHS2448EA5M6A	All-Steel	24	48	22 to 28	Mold-On Rubber	6	1500
RWH3060EA5M6A	Wood	30	60	24½ to 30½	Mold-On Rubber	6	1500
RWHV3060EA5M6A	Structural Foam	30	60	24½ to 30½	Mold-On Rubber	6	1500
RWHS3060EA5M6A	All-Steel	30	60	22 to 28	Mold-On Rubber	6	1500

\* See page 71 for full description of casters and wheels.

## Semi-Live Skids

TONGUE AND GROOVE  
HARDWOOD DECK



- **EFFICIENT** – Can be used with a forklift or lift jack
- **VARIETY** – Deck sizes: 24" x 48", 30" x 60" (2 wheels standard)

Semi-Live Skids - 2 Wheels		Caster		
Model No.	Description	Type*	Size (In.)	Weight Capacity (lbs.)
RA778MR	Tongue & Groove Hardwood Deck	Mold-On Rubber	8	2200
RA756MR	Tongue & Groove Hardwood Deck	Mold-On Rubber	6	1800

Lift Jacks			Caster	
Model No.	Description	Handle Style	Type*	Size (In.)
RM718MR‡	Male Lift Jack	(T) or (Loop)	Mold-On Rubber	8
RF718MR‡	Female Lift Jack	(T) or (Loop)	Mold-On Rubber	8

\* See page 71 for full description of casters and wheels. ‡ - Specify Handle Style (T) or (Loop) when ordering.





# ProCart™

## VERSATILE STRUCTURAL FOAM UTILITY CART

800.253.2467  
akro-mils.com



**COLOR**  
Gray

### FEATURES

- 1 Hinged side gates on both shelves flip up or down to convert the ProCart to a flat-top or box-top cart
- 2 Deep, molded-in compartments keep items within reach (Only large cart has cup holder)
- 3 Comfortable, full-width handle gives complete handling control
- 4 Smooth, rounded corners and edges
- 5 Toe-touch, locking swivel wheels
- 6 Durable, non-marking 5" wheels: 1 1/4" x 3" caster bolt pattern
- 7 I-beam post makes loading and unloading oversized boxes on the lower shelf easy
- 8 Optional rail systems (sold separately) allow AkroBins®, Super Modular Cabinets or 19-Series Steel Cabinets to hang

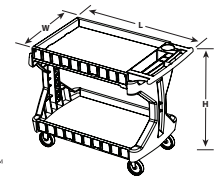

**ProCart™**

ProCart		Dimensions (In.)			Ctn. Qty.
Model No.	Description	L	W	H	
30936	Large Cart	45 3/8	24	34 3/4	1
30930	Small Cart	41 1/2	19	34 3/4	1

ProCart Rail Kits	
Model No.	Description
30900	Small Cart 9-Rail System
30906	Large Cart 9-Rail System
30902	Large Cart 2-Rail System for Super Modular Cabinets

Easy assembly – requires Phillips screwdriver and rubber mallet.

### PRODUCT HIGHLIGHTS

- **VERSATILE** – All-purpose utility cart for the assembly line, warehouse or wherever you need portable storage
- **DURABLE** – High-density structural foam construction is dent-resistant, rust-proof and never needs painting
- **CAPACITY** – 400 lb. maximum cart load. 200 lb. capacity per top and bottom shelf
- **ASSEMBLY** – Light assembly required
- **VARIETY** – 2 sizes

### AkroBins Ordering Information

To create a customized ProCart with AkroBins, use the chart below to determine the quantity of bins that will fit your ProCart. Carts, rail kits and bins must be ordered separately. When ordering, please specify color. See pages 4-5 for more information.

Use this chart when ordering one size AkroBins and 19-Series Cabinets for your ProCart

Bin Model No. Bin Dim. L x W x H	30210 5 7/8 x 4 1/8 x 3	30220 7 7/8 x 4 1/8 x 3	30224 10 7/8 x 4 7/16 x 4	30230 10 7/8 x 5 1/2 x 5	30234 14 3/4 x 5 1/2 x 5	30235 10 7/8 x 11 x 5	30239 10 3/4 x 8 3/4 x 7	30240 14 3/4 x 8 3/4 x 7	30250 14 3/4 x 16 1/2 x 7	30255 10 3/4 x 16 1/2 x 5	30320 8 7/8 x 33 x 5	19-Series Cabinet*
30936 Large Cart	80	80	48	36	36	18	16	16	8	12	6	4
30930 Small Cart	70	70	42	30	–	12	12	–	–	–	–	2

\*Requires 98400 Suspension Straps for hanging.

### RELATED PRODUCTS

Increase the benefits of your ProCart with



4-5 AkroBins



21 Akro-Grids



38 19-Series Steel Cabinets



45 Super Modular Cabinets

# Louvered Carts

MOBILE WORKSTATION ACCOMMODATES AKRODRAWERS® & AKROBINS®

800.253.2467  
akro-mils.com



**COLORS**  
Textured Charcoal Gray, Textured Putty



## FEATURES

- 1 Welded steel frame
- 2 Tubular push handle featured on end of carts for easy handling
- 3 Louvered panels on cart end accommodate various sizes of AkroBins
- 4 Steel-reinforced butcher block work surface
- 5 Raised barriers near shelf edges keep AkroDrawers from sliding out when cart is in motion
- 6 2 rigid casters, 2 swivel casters with total lock brakes



## PRODUCT HIGHLIGHTS

- **VERSATILE** – Industrial-grade mobile workstation
- **DURABLE** – Made from 16-gauge steel with a durable powder-coated finish
- **CAPACITY** – Non-marking blue elastic rubber casters allow a weight capacity of 800 lbs.
- **NO ASSEMBLY** – Ships fully assembled and ready to use
- **VARIETY** – 2 worktop sizes: 48" L x 24" W, and 36" L x 18" W. Colors: Textured Charcoal Gray, Textured Putty

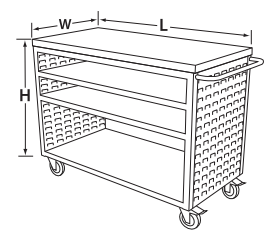

Small Louvered Cart 37" L x 18" W x 36" H			Capacity/Qty.		
Model No.	Description	Cart Color	Wt. Capacity (lbs.)	Qty. of Drawers	Drawer Color
MA3618C MA3618P	Small Louvered Cart with no AkroDrawers	Textured Charcoal Gray Textured Putty	800	-	-
MA3618C1 MA3618P1	Small Louvered Cart with 31118 AkroDrawers	Textured Charcoal Gray Textured Putty	800	6	R,B,Y,GRY,CRY B,CRY
MA3618CAST MA3618PAST	Small Louvered Cart with 31168 & 31188 AkroDrawers	Textured Charcoal Gray Textured Putty	800	12 / 4	R,B,Y,GRY,CRY B,CRY

Specify drawer color when ordering: Red, Blue, Yellow, Gray or Crystal Clear available with Gray Cart. Blue or Crystal Clear available with Putty Cart. Only one color per unit.

Large Louvered Cart 49" L x 24" W x 37½" H			Capacity/Qty.		
Model No.	Description	Cart Color	Wt. Capacity (lbs.)	Qty. of Drawers	Drawer Color
MA4824C MA4824P	Large Louvered Cart with no AkroDrawers	Textured Charcoal Gray Textured Putty	800	-	-
MA4824C1 MA4824P1	Large Louvered Cart with 31142 & 31162 AkroDrawers	Textured Charcoal Gray Textured Putty	800	22 / 16	R,B,Y,GRY,CRY B,CRY
MA4824C2 MA4824P2	Large Louvered Cart with 31142 & 31182 AkroDrawers	Textured Charcoal Gray Textured Putty	800	22 / 10	R,B,Y,GRY,CRY B,CRY
MA4824C3 MA4824P3	Large Louvered Cart with 31112 AkroDrawers	Textured Charcoal Gray Textured Putty	800	16	R,B,Y,GRY,CRY B,CRY

Specify drawer color when ordering: Red, Blue, Yellow, Gray or Crystal Clear available with Gray Cart. Blue or Crystal Clear available with Putty Cart. Only one color per unit.

**AkroDrawers®**

AkroDrawers	Outside Dimensions (in.)		
Model No.	L	W	H
31142	11½"	3¾"	4½"
31148	17½"	3¾"	4½"
31162	11½"	5½"	4½"
31182	11½"	8½"	4½"
31164	23½"	5½"	4½"
31168	17½"	5½"	4½"
31188	17½"	8½"	4½"
31112	11½"	11½"	4½"
31118	17½"	11½"	4½"



# Shelf Carts

HEAVY-DUTY CARTS ARE DESIGNED FOR DAILY WORK



R1S5HR  
24x36

UP TO  
2200  
LBS.

MADE  
IN THE  
USA



R5ST8MR  
30x48

COLOR  
Gray



## FEATURES

- 1 Heavy-duty, 13-gauge welded steel frame and shelves
- 2 Models feature 1½" lips down shelves
- 3 Variety of bolt-on casters available
- 4 Swayback, vertical and horizontal tubular push handles available

## PRODUCT HIGHLIGHTS

- **DURABLE** – Made from 13-gauge steel with a durable powder-coated finish
- **CAPACITY** – Built to withstand loads up to 2,200 lbs. with recommended casters
- **NO ASSEMBLY** – Ships fully assembled and ready to use
- **VARIETY** – Cart sizes: 24" x 36", 24" x 48", 30" x 48", 30" x 60". Choose from several caster options as well as rubber matting, a writing shelf and drawers

## ACCESSORIES



Drawer

### Handle Options



Swayback



Horizontal  
Tubular



Vertical



Writing  
Shelf



Rubber  
Matting



Wheel  
Locks

Shelf Carts						
Model No.	Height (In.)	Shelf Clearance (In.)	Shelves	Caster	Handle Style	Weight Capacity (lbs.)
R1S8FP2	33½	20¾	2	8" Full Pneumatic	Swayback	1200
R1S10FP2	35¼	20¾	2	10" Full Pneumatic	Swayback	1200
R1S5HR	30	20¾	2	5" x 2" Polyolefin	Vertical	1800
R1S5HR2LD	25	15½	2	5" x 2" Polyolefin	Swayback	1800
R1S8MR	33	20¾	2	8" x 2" Mold-On Rubber	Vertical	2200
R1S8MR2	33	20¾	2	8" x 2" Mold-On Rubber	Swayback	2200
R2ST5HR	30	20¾	2	5" x 2" Polyolefin	Horiz. Tubular	1800
R3ST5HR	30	9%	3	5" x 2" Polyolefin	Horiz. Tubular	1800
R4ST5HR	63¼	17	4	5" x 2" Polyolefin	Horiz. Tubular	1800
R4ST8MR	66¼	17	4	8" x 2" Mold-On Rubber	Horiz. Tubular	2200
R5ST5HR	63¼	12½	5	5" x 2" Polyolefin	Horiz. Tubular	1800
R5ST8MR	66¼	12½	5	8" x 2" Mold-On Rubber	Horiz. Tubular	2200

Specify shelf size and lips up or lips down when ordering. Standard shelves are lips down.



R5SYT5HR2436

MADE  
IN THE  
USA

System Bin Multi-Shelf Carts		Dimensions (In.)			Shelves	Caster	Handle (In.)	Bin/Qty.	Color	Weight Capacity (lbs.)
Model No.	L	W	H							
R5SYT5HR2436	36	24½	40	5	5" x 2" Polyolefin	Horiz. Tubular	30312/10*	R, Y, B	1800	
R5SYT8MR2436	36	24½	43	5	8" x 2" Mold-On Rubber	Horiz. Tubular	30312/10*	R, Y, B	2200	
R5SYT5HR3636	36	36½	40	5	5" x 2" Polyolefin	Horiz. Tubular	30318/10**	R, Y, B	1800	
R5SYT8MR3636	36	36½	43	5	8" x 2" Mold-On Rubber	Horiz. Tubular	30318/10**	R, Y, B	2200	

Bin color code: R=Red, B=Blue, Y=Yellow. Specify bin color when ordering. \*Qty. of 30312 System Bins included. \*\*Qty. of 30318 System Bins included.



# Specialty Carts

HEAVY-DUTY MOBILE CARTS FOR HEAVY, BULKY ITEMS

800.253.2467  
akro-mils.com



UP TO  
**1800**  
LBS.

R1B5HRXL



### CASTERS & WHEELS

Caster & Wheel choices allow you to resolve problems of noise control, floor protection, impact or abrasion resistance, or load capacity. See page 71 for more caster information.

COLOR  
Gray



## Box Trucks

- **DURABLE** – Made from 13-gauge all-welded steel with 2" hemmed edges or #13 expanded metal in 1½" x 1½" x ⅛" angle frame
- **CAPACITY** – 1,800 lb. weight capacity. Steel Box dimensions: 30½" overall height, 24" interior depth; Expanded Metal Box dimensions: 31½" overall height, 25" interior depth
- **CASTERS** – All box trucks have 2 swivel, 2 rigid, 5" x 2" polyolefin casters (additional caster types available)
- **SECURE** – Lids can be secured with padlock or combination lock
- **VARIETY** – Solid steel or expanded metal sides available. Box sizes: 24" x 36", 24" x 48", 30" x 36", 30" x 48". Available with optional lid

### Box Trucks

Model No.	Description	Caster Type	Weight Capacity (lbs.)
R1B5HR	Solid Steel Box Truck	5" Polyolefin	1800
R1B5HRL	Solid Steel Box Truck with Lid	5" Polyolefin	1800
R1B5HRX	Expanded Metal Box Truck	5" Polyolefin	1800
R1B5HRXL	Expanded Metal Box Truck with Lid	5" Polyolefin	1800

## Tray Service Cart

- **EFFICIENT** – Excellent for library, manufacturing and food service operations
- **DURABLE** – 13-gauge all-welded steel construction features 12" deep tray and 12⅛" clear shelf spacing with 1½" lip
- **CASTERS** – 2 swivel, 2 fixed
- **HANDLE** – Tubular push handle for easy handling
- **VARIETY** – Standard sizes include 18" x 30", 24" x 36", 24" x 48"; optional size: 18" x 36"

UP TO  
**2200**  
LBS.



R2T5HR1830



COLOR  
Gray



Tray Service Cart	Dimensions (In.)			Casters	Weight Capacity (lbs.)
Model No.	L	W	H		
R2T5HR1830	18	30	32½	5" Polyolefin	1800
R2T5HR2436	24	36	32½	5" Polyolefin	1800
R2T5HR2448	24	48	32½	5" Polyolefin	1800
R2T8MR2448	24	48	35½	8" Mold-On Rubber	2200

## Super-Size AkroBin® Carts



UP TO  
**1500**  
LBS.

R214CS1878

- **MOBILE** – Mobilize your Super-Size AkroBins
- **EFFICIENT** – Easy organization of bulky parts
- **DURABLE** – Made from 11-gauge steel
- **CAPACITY** – Heavy-duty frames with weight capacities from 900 to 1,500 lbs.
- **VARIETY** – 4, 6, 9, 12 and 16-bin configurations (Super-Size AkroBins sold separately). Carts have 5" x 2" polyolefin casters. Optional security bar available for all sizes.

COLOR  
Gray



Super-Size AkroBin Steel Carts		Dimensions (In.)			No. of Handles	Accessories	Capacity/Qty.	
Model No.	Bin Compatibility	L	W	H		Security Bar	Capacity (lbs.)	Ctn. Qty.
R214CS1841	Six 30283 Bins	41	18	48	2	RSSAKBINHDDWN6	900	1
R214CS1859	Nine 30283 Bins	59	18	48	2	RSSAKBINHDDWN9	1350	1
R214CS1878	Twelve 30283 Bins	78	18	48	2	RSSAKBINHDDWN12	1500	1
R214CS2841	Six 30290 Bins	41	27½	48	2	RSSAKBINHDDWN6	900	1
R214CS2859	Nine 30290 Bins	59	27½	48	2	RSSAKBINHDDWN9	1350	1
R214CS2878	Twelve 30290 Bins	78	27½	48	2	RSSAKBINHDDWN12	1500	1
R216CS2236	Sixteen 30284 Bins or six 30286 Bins or six 30287 Bins or four 30288 Bins	35½	22½	35	1	–	900	1
R216CS2836	Six 30292 Bins or four 30293 Bins	35½	28½	35	1	–	900	1
R216CS2239	Four 30289 Bins	35½	22½	39	1	–	900	1

Optional security bar available for all sizes. Bins sold separately.

# Portable Tables & Carts : Mobile Work Tables

VERSATILE MOBILE SYSTEMS & WORK CENTERS

## Portable Tables & Carts

- **VERSATILE** – Carts are ideal for stock picking, assembly operations or other heavy-duty tasks
- **DURABLE** – All-welded, 16-gauge steel construction. Gray powder-coated finish. Angle posts for added strength. Ships fully assembled!
- **CASTERS** – Non-marking thermo-plastic 5" x 1 1/4" soft rubber casters for quiet and smooth maneuverability
- **DRAWER** – High-quality storage drawer is padlock-ready
- **VARIETY** – 2 sizes. Optional drawer, writing shelf, rubber shelf matting, wheel locks are available (sold separately)

Portable Tables							
Model No.	Cart Size (In.)	Height (In.)	Shelf Clearance (In.)	Shelves	Caster	Handle Style	Weight Capacity (lbs.)
RMD2ST5SR	24 x 36	36	27	2	2 Swivel / 2 Rigid	Tubular	800
RMD3ST5SR	24 x 36	36	12 1/2	3	2 Swivel / 2 Rigid	Tubular	800



UP TO 800 LBS.

RMD2ST5SR1830WE

COLOR Gray



## Mobile Work Tables – Heavy-Duty

- **MULTI-SHELF** – Includes 21" D x 36" W bottom shelf; 13 1/2" D x 37" W tilted shelf for easy access to bins
- **DURABLE** – Industrial-grade mobile workstation with a welded-steel frame and steel-reinforced premium oak top. Gray powder-coated finish. Ships fully assembled!
- **ADJUSTABLE** – 24" L x 48" W work area with 9 adjustable height settings from 36" to 48"
- **WOOD TOP** – Kiln-dried hardwood work surface extends 2" to accommodate vise or clamps; wood top is premium oak boards with rounded edges 2 1/4" in overall thickness; individual planks are 1 1/8" (5/4); optional butcher block top available
- **CASTERS** – 5" x 2" bolted-on polyurethane casters; 2 rigid, 2 swivel with total lock brakes

Mobile Work Tables - Heavy-Duty		Dimensions (In.)			Caster		
Model No.	Deck Type	L	W	H	Type	Size (In.)	Weight Capacity (lbs.)
RHWB2448P5PYOG	Oak Hardwood	24	48	36 to 48	Polyurethane	5 x 2	800

COLOR Gray



UP TO 800 LBS.

RHWB2448P5PYO



## Mobile Work Tables – Medium-Duty

- **DURABLE** – Industrial-grade mobile workstation with a welded-steel frame and steel-reinforced tongue and groove hardwood top. Gray powder-coated finish. Ships fully assembled!
- **CASTERS** – 2 bolted-on non-marking thermo-plastic soft rubber casters; 2 swivel 5" x 1 1/4" casters with total lock brakes
- **DRAWERS** – 2 padlock-ready steel drawers: 15 3/4" W x 6 3/4" H x 20" D

Mobile Work Tables - Medium-Duty		Dimensions (In.)			Caster		
Model No.	Deck Type	L	W	H	Type	Size (In.)	Weight Capacity (lbs.)
RMWB24485SRTPG	Hardwood	24	48	36	Thermo-Plastic	5 x 1 1/4	800

COLOR Gray



UP TO 800 LBS.

RMWB24485SRTP





# Heavy-Duty Work Benches

## ADJUSTABLE & FIXED WORK HEIGHTS

800.253.2467  
akro-mils.com

### FEATURES

- 1 11-gauge steel work surface extends 1½" on front and sides to accommodate a vise or clamps (hardwood extends 2')
- 2 Wraparound steel backstop keeps items from falling behind work bench
- 3 Adjustable work height telescoping C-channel legs provide a range of work heights from 30" to 40" (1½" increments)
- 4 12-gauge welded steel shelves
- 5 13½" deep middle shelf is sloped for easy access to bins or containers
- 6 Anchor pads on each leg secure bench in a fixed position
- 7 Durable powder-coated finish

### PRODUCT HIGHLIGHTS

- **DURABLE** – Heavy-duty steel frame work bench. Gray powder-coated finish.
- **VARIETY** – Bench sizes: 30" x 60" and 30" x 72". Fixed or adjustable work heights. Steel, kiln-dried premium hardwood, butcher block or composition work surface. Work surface thickness: wood 2¼"; butcher block 1¾"; composition 1¾"



## How to Order Your Work Bench

### STEP 1

#### PICK A SIZE

Standard work table sizes:  
30" x 60" • 30" x 72"

### STEP 2

#### PICK FRAME COLOR (G)

Standard color:  
Gray

### STEP 3

#### PICK HEIGHT STYLE (F, A)

Fixed Height:  
34" high

Adjustable Height:  
30" - 40" high

### STEP 4

#### PICK SHELF OPTIONS (1, 2, 3, 4)

- Option 1:**  
Both shelves FORWARD, toward the front of the bench
- Option 2:**  
Both shelves BACK, toward the back of the bench
- Option 3:**  
Middle shelf FORWARD, bottom shelf BACK
- Option 4:**  
Middle shelf BACK, bottom shelf FORWARD

### STEP 4

#### PICK WORK SURFACE (S, P, B, C)

- Steel (S):**  
11-gauge steel
- Hardwood (P):**  
Premium kiln-dried hardwood 2¼" thick
- Butcher Block (B):**  
1¾"
- Composition (C):**  
1¾"

Call your Akro-Mils distributor with your model number today to order

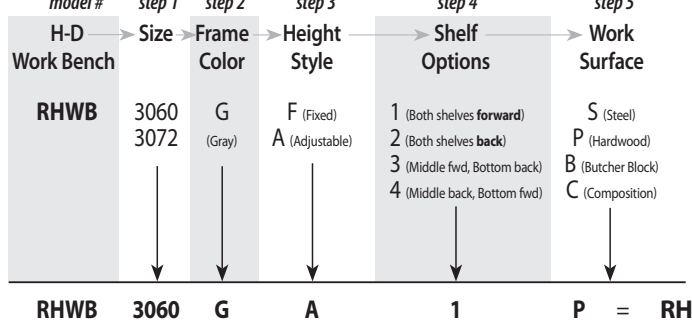

Ships fully assembled & ready to use!

MADE IN THE USA





# Dollies: Wood

KILN-DRIED HARDWOODS PREVENT WARPING & SHRINKAGE



## FEATURES

- 1 Kiln-dried hardwood deck with countersunk bolt holes for a smooth working surface
- 2 Non-marking bolt-on 3" swivel casters with polyolefin wheels for maximum mobility
- 3 Zinc-plated rigs and hardware resist corrosion

## PRODUCT HIGHLIGHTS

- **QUALITY** – All boards are cut and planed to  $\frac{7}{8}$ " with guaranteed consistent quality
- **CAPACITY** – Four 3" polyolefin swivel casters offer 900 lb. weight capacity (See caster options for up to 1,400 lb. capacity)
- **VARIETY** – Dolly styles include Solid, Flush, Regular, Carpet End, Rubber Cap, All-Carpet Solid

All 3" polyolefin casters are not alike! Akro-Mils gives you more of what you paid for! See page 71.

## ACCESSORIES



Wheel Locks

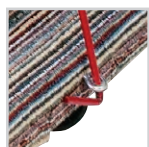

Tow Eye R1495

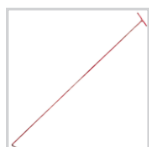

Tow Handle RTOWHANDLE Tee-handle dolly pull hook made from  $\frac{5}{16}$ " diameter steel.

Wood Dollies		Dimensions (In.)	
Model No.	Description	L	W
RD2416S3P	Solid Dolly	24	16
RD2718S3P	Solid Dolly	27	18
RD3018S3P	Solid Dolly	30	18
RD3624S3P	Solid Dolly	36	24
RD4824S3P	Solid Dolly	48	24
RD2416F3P	Flush Dolly	24	16
RD2718F3P	Flush Dolly	27	18
RD3018F3P	Flush Dolly	30	18
RD3624F3P	Flush Dolly	36	24
RD4824F3P	Flush Dolly	48	24
RD2416R3P	Regular Dolly	24	16
RD3018R3P	Regular Dolly	30	18
RD3624R3P	Regular Dolly	36	24
RD3018CE3P	Carpet End Dolly	30	18
RD3624CE3P	Carpet End Dolly	36	24
RD2718RC3P	Rubber Cap Dolly	27	18
RD3018RC3P	Rubber Cap Dolly	30	18
RD3018AC3P	All-Carpet Solid Dolly	30	18
RD3624AC3P	All-Carpet Solid Dolly	36	24



## CASTERS & WHEELS

Caster & Wheel choices allow you to resolve problems of noise control, floor protection, impact or abrasion resistance, or load capacity. See page 71 for more caster information.

Caster Options		
Model No.	Description	Weight Capacity (lbs.)
3P ‡	3" Polyolefin Casters	900
4P	4" Polyolefin Casters	1200
5P	5" Polyolefin Casters	1400
3R	3" Gray Non-Marking Rubber	900
35R	3½" Gray Non-Marking Rubber	900
4Rx	4" Blue Elastic Rubber	900
4R	4" Non-Marking Rubber Casters	1100
5R	5" Non-Marking Rubber Casters	1350

‡ Standard casters.

Brake Kits	
Model No.	Description
R1130BRK	3" Brake Kits for Hard Rubber Casters
R1151BRK	3" Brake Kits for Polyolefin Casters

Brake kits installed on two swivel casters – optional (non-returnable).

# Dollies: Polyethylene

DURABLE INDUSTRIAL-GRADE POLYMER DOLLIES

800.253.2467  
akro-mils.com



MADE  
IN THE  
USA



RMD3018RC4PN



RMD3018F4PN

**COLORS**  
Red, Blue



## FEATURES

- 1 1-piece deck design
- 2 Steel-reinforced under deck
- 3 High-impact, durable polyethylene construction
- 4 Flush deck or padded models available for cargo protection
- 5 4 bolt-on swivel casters for maximum mobility

## PRODUCT HIGHLIGHTS

- **QUALITY** – Easy to clean, non-porous platform will not rot, mildew or splinter
- **CAPACITY** – 1,200 lb. weight capacity
- **ASSEMBLY** – Quick, easy assembly
- **VARIETY** – 6 models, 2 colors

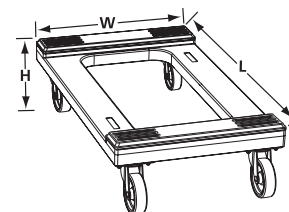

Polyethylene Dollies		Dimensions (In.)				
Model No.	Description	L	W	Caster Type	Overall Height (In.)	Weight Capacity (lbs.)
RMD3018F4PN	Flush Polyethylene w/ Casters	30	18	4" Polyolefin	7¾	1200
RMD3018RC4PN	Padded Polyethylene w/ Casters	30	18	4" Polyolefin	8¾	1200
RMD3018FN	Flush Polyethylene w/o Casters	30	18	–	2¾	–
RMD3018RCN	Padded Polyethylene w/o Casters	30	18	–	3¾	–
RMD3018F4RX	Flush Polyethylene w/ Casters	30	18	4" Blue Elastic Rubber	7¾	1200
RMD3018RC4RX	Padded Polyethylene w/ Casters	30	18	4" Blue Elastic Rubber	8¾	1200

Specify color when ordering.

### CASTERS & WHEELS

Caster & Wheel choices allow you to resolve problems of noise control, floor protection, impact or abrasion resistance, or load capacity. See page 71 for more caster information.



# Dollies: Steel

HEAVY-DUTY, ALL-STEEL CONSTRUCTION

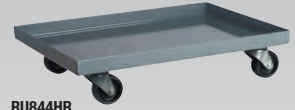

RU844HR

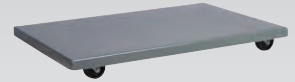

RD844HR



RU854HR



RD854HR

COLOR  
Gray



## FEATURES

- 1 Durable, powder-coated finish
- 2 All-welded 13-gauge steel or 1½" x 1½" x 1/8" angle construction
- 3 Bolt-on casters for easy replacement

## PRODUCT HIGHLIGHTS

- **OPEN** – Open structural angle dollies, 1½" x 1½" x 1/8"
- **SOLID** – Solid decks are smooth, 13-gauge steel
- **LIPS UP or DOWN** – 1½" lip turned down for a smooth surface; order lips up for a contained area
- **CAPACITY** – Up to 1,000 lbs.
- **VARIETY** – 4 models, 4 sizes: 16" x 27", 18" x 24", 18" x 30", 24" x 36". Custom sizes and casters available

### CASTERS & WHEELS

Caster & Wheel choices allow you to resolve problems of noise control, floor protection, impact or abrasion resistance, or load capacity. See page 71 for more caster information.

Steel Dollies							
Style	Lips Down Model No.	Lips Up Model No.	Capacity (lbs.)	Caster Type	Caster Size (In.)	Deck Height Up (Inches)	Deck Height Down (Inches)
Solid Dolly	RD843HR	RU843HR	900	Polyolefin	3 x 1¼	5½	4¾
Solid Dolly	RD843SS	RU843SS	1000	Steel	3 x 1¼	5½	4¾
Solid Dolly	RD844HR	RU844HR	1000	Polyolefin	4 x 1¼	6¾	5¼
Solid Dolly	RD844SS	RU844SS	1000	Steel	4 x 1¼	6¾	5¼
Open Angle	RD853HR	RU853HR	900	Polyolefin	3 x 1¼	5¾	4¾
Open Angle	RD853SS	RU853SS	1000	Steel	3 x 1¼	5¾	4¾
Open Angle	RD854HR	RU854HR	1000	Polyolefin	4 x 1¼	6¾	5½
Open Angle	RD854SS	RU854SS	1000	Steel	4 x 1¼	6¾	5½

## ACCESSORIES

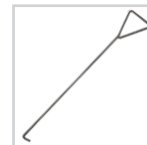

**RHDHOOK**  
Heavy-duty pull hook from ½" diameter steel for pulling dollies. Tow Hook includes a weld-on eye.



# Dollies: Steel

CUSTOM SIZES TO FIT BINS & CONTAINERS

800.253.2467  
akro-mils.com



RU843TP1721 with 30288



RU843HR1519 with 13017



RU843HR1828 with 35300



RU843HR1621 with 33226



RU843HR1420 with 39120



RU843HR1624 with 37688



Super-Size AkroBin Steel Dollies		Dimensions (In.)			Capacity/Qty.		
Model No.	Bin Compatibility	L	W	H	Casters	Capacity (lbs.)	Ctn. Qty.
RU843HR2018	30280, 30281, 30282 & 30283 Bins – Fits 1 wide	17 <sup>3</sup> / <sub>16</sub>	18 <sup>3</sup> / <sub>16</sub>	4 <sup>1</sup> / <sub>16</sub>	3" Polyolefin	900	1
RU843HR2918	30290 Bins – Fits 1 wide	26 <sup>3</sup> / <sub>16</sub>	18 <sup>3</sup> / <sub>16</sub>	4 <sup>1</sup> / <sub>16</sub>	3" Polyolefin	900	1
RU843TP2122	30286 & 30287 Bins – Fits 2 wide	20 <sup>7</sup> / <sub>16</sub>	21 <sup>7</sup> / <sub>16</sub>	4 <sup>1</sup> / <sub>16</sub>	3" Polyolefin	900	1
RU843TP2227	30292 Bins – Fits 2 wide	21 <sup>7</sup> / <sub>16</sub>	26 <sup>7</sup> / <sub>16</sub>	4 <sup>1</sup> / <sub>16</sub>	3" Polyolefin	900	1
RU843TP1721	30284 Bins – Fits 2 wide 30288 Bins – Fits 1 wide	16 <sup>1</sup> / <sub>2</sub>	20 <sup>7</sup> / <sub>16</sub>	4 <sup>1</sup> / <sub>16</sub>	3" Polyolefin	900	1
RU843TP1727	30293 Bins – Fits 1 wide	16 <sup>1</sup> / <sub>2</sub>	26 <sup>7</sup> / <sub>16</sub>	4 <sup>1</sup> / <sub>16</sub>	3" Polyolefin	900	1
RU843TP1821	30289 Bins – Fits 1 wide	18 <sup>1</sup> / <sub>2</sub>	20 <sup>7</sup> / <sub>16</sub>	4 <sup>1</sup> / <sub>16</sub>	3" Polyolefin	900	1

Bins sold separately, see page 7.

UP TO  
900  
LBS.

Stak-N-Store Bin Steel Dollies		Dimensions (In.)			Capacity/Quantity		
Model No.	Bin Compatibility	L	W	H	Casters	Ctn. Qty.	Capacity
RU843HR1617	13018	16 <sup>1</sup> / <sub>2</sub>	15 <sup>1</sup> / <sub>2</sub>	4 <sup>1</sup> / <sub>2</sub>	3" Polyolefin	1	900 lbs.
RU843HR1519	13017	19 <sup>1</sup> / <sub>4</sub>	14 <sup>1</sup> / <sub>2</sub>	4 <sup>1</sup> / <sub>2</sub>	3" Polyolefin	1	900 lbs.

Bins sold separately, see page 10.

UP TO  
900  
LBS.

Nest & Stack Tote Steel Dollies		Dimensions (In.)			Capacity/Quantity		
Model No.	Bin Compatibility	L	W	H	Casters	Ctn. Qty.	Capacity
RU843HR1422	35240	16 <sup>1</sup> / <sub>2</sub>	15 <sup>1</sup> / <sub>2</sub>	4 <sup>1</sup> / <sub>2</sub>	3" Polyolefin	1	900 lbs.
RU843HR1822	35225, 35230	21 <sup>1</sup> / <sub>2</sub>	17 <sup>1</sup> / <sub>2</sub>	4 <sup>1</sup> / <sub>2</sub>	3" Polyolefin	1	900 lbs.
RU843HR1828	35300	27 <sup>1</sup> / <sub>2</sub>	17 <sup>1</sup> / <sub>2</sub>	4 <sup>1</sup> / <sub>2</sub>	3" Polyolefin	1	900 lbs.

Bins sold separately, see page 19.

UP TO  
900  
LBS.

Akro-Grid Steel Dollies		Dimensions (In.)			Capacity/Quantity		
Model No.	Bin Compatibility	L	W	H	Casters	Ctn. Qty.	Capacity
RU843HR1621	33220, 33228	21 <sup>1</sup> / <sub>2</sub>	16 <sup>1</sup> / <sub>2</sub>	5 <sup>1</sup> / <sub>2</sub>	3" Polyolefin	1	900 lbs.

Bins sold separately, see page 21.

UP TO  
900  
LBS.

Attached Lid Container Steel Dollies		Dimensions (In.)			Capacity/Quantity		
Model No.	Bin Compatibility	L	W	H	Casters	Ctn. Qty.	Capacity
RU843HR1420	39085, 39120, 39170	19 <sup>1</sup> / <sub>2</sub>	14 <sup>1</sup> / <sub>2</sub>	5 <sup>1</sup> / <sub>2</sub>	3" Polyolefin	1	900 lbs.

Bins sold separately, see page 22.

UP TO  
900  
LBS.

Straight Wall Container Steel Dollies		Dimensions (In.)			Capacity/Quantity		
Model No.	Bin Compatibility	L	W	H	Casters	Ctn. Qty.	Capacity
RU843HR1624	37608, 37678, 37688, 37616, 37676, 37686, 37612, 37672, 37682	24 <sup>1</sup> / <sub>2</sub>	16 <sup>1</sup> / <sub>2</sub>	5 <sup>1</sup> / <sub>2</sub>	3" Polyolefin	1	900 lbs.

Bins sold separately, see page 23.

UP TO  
900  
LBS.



# Hand Trucks

HEAVY-DUTY : MEDIUM-DUTY : GAS : CYLINDER



## Heavy-Duty Hand Trucks

- **HEAVY-DUTY** – Hand trucks ideal for all types of loads
- **FRAME** – 1" OD structural pipe frame, 13-gauge steel
- **NOSE PLATE** – Standard 8" x 14" size. Optional 10" x 14" or 14" x 14" nose plate available, 7-gauge steel
- **WHEELS** – Two-position bracket fits 8" or 10" wheels
- **HANDLES** – Flow Back or Dual Loop handles



## Medium-Duty Hand Trucks

- **FUNCTIONAL** – Hand trucks for day-to-day tasks
- **DURABLE** – Heavy-flat bar and tube for climbing stairs
- **FRAME** – 7/8" OD structural pipe frame, 13-gauge wall
- **NOSE PLATE** – Standard 7" x 14" size, 7-gauge steel
- **WHEELS** – Two-position bracket fits 8" or 10" wheels



## 4-Wheel Gas Cylinder Trucks

- **HEAVY-DUTY** – Designed to handle 330 cu. ft. cylinders
- **FRAME** – 1" OD structural pipe frame, 13-gauge wall
- **NOSE PLATE** – Standard 7" x 14" size, 7-gauge steel
- **WHEELS** – 4" polyolefin swivel casters



## Standard Gas Cylinder Trucks

- **MEDIUM-DUTY** – Perfect for medium to large cylinders
- **VERSATILE** – Transports boxes or other bulky items
- **FUNCTIONAL** – Includes heavy-duty holding chain

COLOR  
Gray



Heavy-Duty Hand Trucks - Flow Back			Dimensions (In.)	
Model No.	Wheel Type	Wheel Size (In.)	H	W
R4008MR	Mold-On Rubber	8	45	19 1/2
R4008MR2	Mold-On Rubber	8	52	19 1/2
R4010FP	Full Pneumatic	10	45	22
R4010FP2	Full Pneumatic	10	52	22
R4010SP	Semi-Pneumatic	10	45	20
R4010SP2	Semi-Pneumatic	10	52	22

Heavy-Duty Hand Trucks - Dual Loop			Dimensions (In.)	
Model No.	Wheel Type	Wheel Size (In.)	H	W
R4510SP	Semi-Pneumatic	10	46	20
R4510SP2	Semi-Pneumatic	10	53	20

COLOR  
Gray



Medium-Duty Hand Trucks - Flow Back			Dimensions (In.)	
Model No.	Wheel Type	Wheel Size (In.)	H	W
R3008MR	Mold-On Rubber	8	45	19 1/2
R3010FP	Full Pneumatic	10	45	22
R3010SP	Semi-Pneumatic	10	45	20

COLOR  
Green



4-Wheel Gas Cylinder Trucks				
Model No.	Truck Type	Wheel Type	Wheel Size (In.)	Base Plate
RGTS10FP	Single	Full Pneumatic	10 x 3 1/2	14" W x 6" D, OAH – 45" 1143
RGTD10FP	Dual	Full Pneumatic	10 x 3 1/2	29" W x 6" D, OAH – 45" 1143
RGTS10SP	Single	Semi-Pneumatic	10 x 2 3/4	14" W x 6" D, OAH – 45" 1143
RGTD10SP	Dual	Semi-Pneumatic	10 x 2 3/4	29" W x 6" D, OAH – 45" 1143

COLOR  
Green



Standard Gas Cylinder Trucks				
Model No.	Description	Wheel Type	Wheel Size (In.)	Base Plate
RCT40LW	Dual with T-Handle	Plain Bore Plastic	8 x 1 3/4	17" W x 8" D, OAH – 43" 1092
RCTV40SP	Single	Semi-Pneumatic	10 x 2 3/4	14" W x 7" D, OAH – 48" 1219



Flow Back Handle (FB)



Dual Loop Handle



T-Handle

# Specialty Hand Trucks

DUAL-PURPOSE : PAIL TRUCK

800.253.2467  
akro-mils.com

## Dual-Purpose Hand Truck

2-IN-1 CONVERTABLE HAND TRUCK

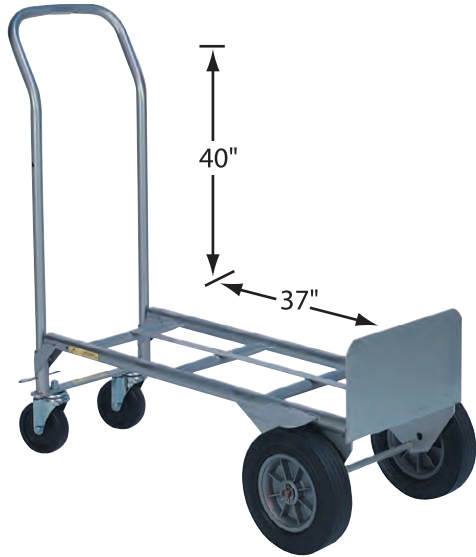

UP TO  
600  
LBS.



COLOR  
Silver



### PRODUCT HIGHLIGHTS

- **VERSATILE** – Dual-function hand truck converts to platform position for oversized loads
- **HEAVY-DUTY** – Welded, 1<sup>5</sup>/<sub>16</sub>" OD tube frame and 1" OD tube handle powder-coated for durability
- **CAPACITY** – Holds up to 600 lbs. in platform mode

Dual-Purpose Hand Truck				
Model No.	Wheel Type	Wheel/Caster Size (In.)	Overall Height (In.)	Overall Width (In.)
RDT4008SP	Semi-Pneumatic	8/3	46	19 $\frac{1}{2}$
RDT4010FP	Full Pneumatic	10/5	46	22
RDT4010SP	Semi-Pneumatic	10/5	46	20



UP TO  
300  
LBS.

## Pail Truck

TRANSPORT 5-GALLON PAIS

### PRODUCT HIGHLIGHTS

- **FUNCTIONAL** – Multi-purpose hand truck for carting 5-gallon pails
- **CAPACITY** – Holds 4 pails, up to 300 lbs. weight capacity

COLOR  
Gray



Pail Truck				
Model No.	Wheel Type	Wheel Size (In.)	Overall Height (In.)	Overall Width (In.)
RPT4010SP	Semi-Pneumatic	10	55 $\frac{1}{2}$	18 $\frac{1}{2}$







# Akro-Tilt Trucks : Akro-Carts

## BULK HANDLING & WASTE TRANSPORT SYSTEMS

### Akro-Tilt Trucks

#### FEATURES

- 1 Versatile tipping truck for heavy-duty jobs
- 2 Wheel base and heavy duty caster combination ease rollability and maneuverability even with high loads
- 3 Fully welded and reinforced frame is optimized for automatic dumper applications
- 4 Tubular frame is constructed of 1.05" O.D. x 13-gauge and 1.3125" O.D. x 13-gauge wall tubes
- 5 77610, 77710, 77810 feature solid 1" axle for maximum durability
- 6 Frame powder-coated for enhanced appearance and rust protection



Akro-Tilt Trucks		Dimensions (In.)			Lid	Wheels		Capacity			
Model No.	Description	W	D	H	Model No.	Wheel Diameter	Wheel Type*	Gallons	Cu. Yds.	Cu. Ft.	Load Rating
77405	Medium-Duty 100	27	54	36	-	12	SP	100	½	13.5	600 lbs.
77410	Medium-Duty 200	33	66	42	77002	12	SP	200	1	27	600 lbs.
77505	Heavy-Duty 100	27	54	36	-	10	MR	100	½	13.5	1000 lbs.
77510	Heavy-Duty 200	33	66	42	77002	10	MR	200	1	27	1000 lbs.
77610	Super Heavy-Duty 200	33	66	42	77002	12	MR	200	1	27	2000 lbs.
77710	Heavy-Duty 300	39	85	51	-	12	MR	300	1½	40.5	2000 lbs.
77810	Heavy-Duty 400	48	85	51	-	12	MR	400	2	54	2000 lbs.

\*SP = Semi-Pneumatic MR = Mold-On Rubber

COLOR  
Gray/Black



### Akro-Carts

#### FEATURES

- 1 NEW AND IMPROVED! Thicker tub walls
- 2 Latch bars extend around the frame for easy loading
- 3 Medium-duty and heavy-duty styles
- 4 Wide mouth and low profile for easy loading
- 5 Heavy-duty piano hinge keeps lid propped open during use
- 6 Black lids on select Akro-Carts
- 7 Swivel caster for easy maneuverability and handling



UP TO  
450  
LBS.

COLORS  
Blue/Black, Green/Black Gray/Black



Akro-Carts			Dimensions (In.)							
Model No. without Lid*	Model No. with Lid	Description	W	D	H	Wheel Size	Wheel Type	Caster	Frame	Load Rating
76460	76461	Medium-Duty 60 Gal. Cap.	30½"	48"	33½"	12 x 2"	Solid Rubber	3 x 1¼" Thermo-Plastic	1" O.D. x 16 ga. galvanized	300 lbs.
76490	76491	Medium-Duty 90 Gal. Cap.	30½"	47"	39½"	12 x 2"	Solid Rubber	3 x 1¼" Thermo-Plastic	1" O.D. x 16 ga. galvanized	350 lbs.
76590	76591	Heavy-Duty 90 Gal. Cap.	30½"	47"	39½"	10 x 2¼"	Semi-Pneumatic	4 x 2 Mold-on Rubber	1.05" O.D. x 13 ga. powder-coated	450 lbs.

Please specify colors when ordering. \*Carts without lids cannot have lids added after production. Single units are shipped completely assembled. When multiple units are ordered, lids are shipped separately and require assembly.

# Caster Information

## HIGH-QUALITY WHEEL & CASTER OPTIONS

800.253.2467  
akro-mils.com

### CASTER SELECTION GUIDE

Standard Casters & Wheels	Description	Image	Floor Surface							Floor Conditions				Other Factors to Consider				
			Asphalt	Brick/Ceramic Tile	Carpet	Concrete	Linoleum - Non-marking	Steel Grate / Dock Plate	Chemicals	Metal Shavings	Oil and Grease	Water and Steam	Floor Protection	Noise	Cushion Load	Impact Resistance	Capacity	Rolling Ease
<b>Mold-On Rubber, Blue Elastic</b>	Designed for medium to heavy loads, these wheels with cushioned rubber tread are quiet and provide good floor protection.		E	E	NR	E	NR	F	NR	NR	F	G	G	E	E	E	G	F
<b>Phenolic</b>	For demanding applications, a less expensive wheel that offers high strength, is non-marking, non-conductive and protects floors.		NR	NR	G	E	G	NR	F	NR	F	F	G	F	NR	F	E	E
<b>Polyolefin</b>	A heavy-duty, lightweight, non-marking plastic wheel that resists most chemicals and oils, and has excellent impact resistance.		NR	NR	G	E	G	NR	G	F	G	E	G	F	NR	G	G	E
<b>Polyurethane</b>	Chemically bonded to a metal core, polyurethane wheels are more durable than other materials, deliver excellent mobility, a cushioned ride and long life when subjected to heavy loads.		E	E	G	E	E	F	G	G	G	G	E	E	G	E	E	G
<b>Pneumatic, Semi-Pneumatic</b>	Air-filled for excellent shock protection, floor protection and easy operation over rough surfaces.		E	E	NR	E	NR	E	NR	NR	F	G	G	E	E	E	F	NR
<b>Steel</b>	A good choice for warehouses and manufacturing operations, and where noise or floor protection are not a concern. Metal wheels offer the least rolling resistance.		NR	NR	NR	E	NR	NR	F	E	G	F	NR	F	NR	NR	E	E
<b>Thermo-Plastic, Grey Non-Marking Rubber</b>	Soft gray rubber wheel provides excellent floor protection and a cushioned ride while resisting chemicals, acids, oils and caustic substances.		E	E	G	E	E	G	E	G	E	G	E	E	E	E	G	G

E = Excellent, G = Good, F = Fair, NR = Not Recommended

### CASTERS & WHEELS

Our generous selection of caster and wheel options allows platform trucks, hand trucks, dollies and shelf carts to be customized to fit hundreds of applications, surfaces and conditions. Caster and wheel choices allow you to resolve problems of noise control, floor protection, impact and abrasion resistance or load capacity.

Caster	Caster Weight Capacities (Lbs.)*						
	10	8	6	5	4	3.5	3
<b>Mold-On Rubber, Blue Elastic</b>	3200	2200	1600	1400	1200	-	-
<b>Phenolic</b>	14,000	4200	3600	3600	-	-	-
<b>Pneumatic</b>	1500	1200	-	-	-	-	-
<b>Polyolefin</b>	-	3200	2600	1800	1000	-	900
<b>Polyurethane</b>	8800	4200	3600	3600	-	-	-
<b>Semi-Pneumatic</b>	2200	-	-	-	-	-	-
<b>Steel</b>	-	4200	3600	3600	1200	-	1000
<b>Thermo-Plastic Grey Non-Marking Rubber</b>	-	600 <sup>†</sup>	-	400 <sup>†</sup>	-	-	-
	-	-	2000	-	-	1000	-

\*Based on evenly distributed load on 4 casters. †Light-duty.

Akro-Mils offers other premium casters for your custom products. Call 800-253-2467 for details.

### IT'S ALL ABOUT THE WHEEL



Other 3" polyolefin caster

Akro-Mils 3" polyolefin caster

Those that depend upon platform trucks, carts and dollies to do their jobs understand that the right caster makes ALL the difference.

For example, not all 3" polyolefin casters are built the same, even if they look similar. Akro-Mils gives you more:

- ➔ **Double Ball Race vs. Single Ball Race.**  
This provides better rotation and control.
- ➔ **Sealed Wheel Hub Ball Bearings vs. Plain Bore.**  
This provides better overall roll ability.
- ➔ **More Structural Wheel Profile.**  
Allows the wheel to be stronger under impact.
- ➔ **Heat-Treated Plate Raceway vs. Non Heat-Treated.**  
This provides better support under load conditions.

GET MORE OF WHAT YOU PAID FOR WITH AKRO-MILS!

# Custom Capabilities

## CUSTOM SOLUTIONS

### Engineering & Design

Akro-Mils' team of engineers and designers draw on a wealth of experience across product and industries to offer creative, practical solutions for your specific needs. Backed by the latest design software and production equipment, your project is guided from concept to delivery in an efficient process that incorporates quality from start to finish. Akro-Mils provides excellence in:

- Product Concept Development
- Process and Material Selection
- Prototype Design, Testing and Development
- Rapid Prototyping
- Final Design
- Tooling/Mold-Making

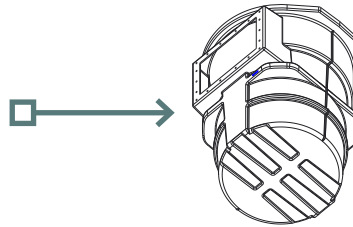
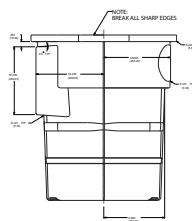
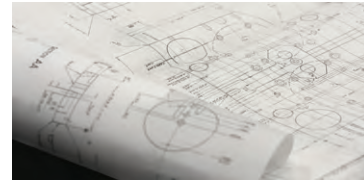

### Custom Molding

Akro-Mils' diverse manufacturing capabilities provide total solutions for custom products. With 5 thermoplastics processes, an extensive resin/colorant selection, and a variety of secondary operations, we match your product to the most effective process for optimal performance and cost efficiency.

#### Our Molding Processes

- Injection Molding
- Rotational Molding
- Structural Foam Molding
- Blow Molding
- Thermoforming

#### Secondary Operations

- Trimming
- Welding
- Threading
- Attachment of Controls, Brackets, etc.
- Full-Modular Assembly
- Component Packaging



### Fabrication – Metal & Wood

Our custom fabricated solutions are designed and built with quality, performance and cost-efficiency in mind. With a wide range of metal and wood fabrication capabilities, Akro-Mils can provide a custom solution to meet your exact needs.

#### Metal:

- Forming/Bending
- Welding
- Powder Coating
- Stamping
- Shearing
- Punching
- Robotic Welding

#### Wood:

- Sawing
- Molding
- Sanding
- Nailing
- Drilling
- Varnishing





# OEM & Merchandising

## CUSTOM SOLUTIONS

800.253.2467  
akro-mils.com

## OEM Solutions

Whether customizing our standard products to meet your specific needs or creating a completely new system, Akro-Mils provides a wide range of options for adapting our products to your primary packaging – or adding value as components of your own products.

- Hot Stamping
- Custom Colors
- Private Labeling
- Sequential Numbering
- Custom Shipping Cartons
- Custom Dunnage
- Product Development for Your Specific Application



## Merchandising Systems

From 3-dimensional plan-o-grams to unique point-of-purchase displays, Akro-Mils will meet your merchandising challenges. Our multiple design options and product configurations provide the creative components you need to maximize space, create eye-catching retail displays, and grow your sales.

- Small Parts Sorting and Display Systems
- Large, Bulk Merchandising Systems
- Bin and Rack Organizing Systems
- Storage Cabinet Systems
- Bin and Tote Shelving Systems
- Custom Colors
- Mobile, Hanging and Freestanding Product Configurations
- Labeling and Graphics Displays



# Product Index

## MATERIAL HANDLING : STORAGE : TRANSPORT PRODUCTS

02420.....	27	30170.....	12	30606GY.....	29	35300.....	19	41288.....	7	ACS4P82.....	43
05705.....	26	30174.....	12	30606GY240.....	29	35301.....	19	41289.....	7	ACS4PAST.....	43
05805.....	26	30178.....	12	30606GY250.....	29	36442BLUE.....	15	41410.....	17	AD1811C.....	45
05905.....	26	30184.....	12	30606GYASST.....	29	36448BLUE.....	15	41440.....	17	AD1811C62.....	45
06115.....	27	30210.....	5	30607GY.....	29	36462BLUE.....	15	41460.....	17	AD1811C82.....	45
06118.....	27	30210ESD.....	8	30607GY240.....	29	36468BLUE.....	15	41480.....	17	AD1811CAST.....	45
06702.....	37	30210RECY.....	8	30607GY250.....	29	37208.....	23	415A1.....	9	AD1811P.....	45
06703.....	37	30211CRY.....	5	30607GYASST.....	29	37278.....	23	415B1.....	9	AD1811P62.....	45
06704.....	37	30220.....	5	30618.....	29	37288.....	23	42105.....	21	AD1811P82.....	45
06705.....	37	30220ESD.....	8	30618BEIGE.....	29	37608.....	23	42164.....	21	AD1811PAST.....	45
06706.....	37	30220RECY.....	8	30636.....	29	37612.....	23	42166.....	21	AD1817C.....	45
06709.....	37	30221CRY.....	5	30636BEIGE1.....	29	37616.....	23	42168.....	21	AD1817C68.....	45
09185BLUE.....	27	30224.....	5	30636BEIGE3.....	29	37672.....	23	42220.....	21	AD1817C88.....	45
09185SCLAR.....	27	30225CRY.....	5	30636BEIGE5.....	29	37676.....	23	42223.....	21	AD1817CAST.....	45
09514.....	26	30230.....	5	30636BEIGEB1.....	29	37678.....	23	42224.....	21	AD1817P.....	45
09912.....	26	30230ESD.....	8	30637.....	30	37682.....	23	42226.....	21	AD1817P68.....	45
10116.....	40	30230RECY.....	8	30637A.....	30	37686.....	23	42228.....	21	AD1817P88.....	45
10124.....	40	30231CRY.....	5	30638.....	29	37688.....	23	46224.....	5	AD1817PAST.....	45
10126.....	40	30234.....	5	30650GY.....	29	39085.....	22	46230.....	5	AD2311C.....	45
10144.....	40	30234RECY.....	8	30650GY240.....	29	39120.....	22	46240.....	5	AD2311C62.....	45
10164.....	40	30235.....	5	30650GY250.....	29	39160.....	22	66486CLDBL.....	22	AD2311P.....	45
12051.....	70	30235ESD.....	8	30650GYASST.....	29	39170.....	22	76460.....	70	AD2311P62.....	45
13014.....	10	30236CRY.....	5	30651.....	29	39175.....	22	76461.....	70	AD3511BSC.....	44
13017.....	10	30239.....	5	30652.....	30	39280.....	22	76490.....	70	AD3511BSP.....	44
13018.....	10	30239RECY.....	8	30653.....	29	40020.....	13	76491.....	70	AD3511C.....	44
17018.....	38	30240.....	5	30653DOLLY.....	29, 30	40030.....	13	76590.....	70	AD3511C62.....	44
19109.....	38	30240ESD.....	8	30654.....	30	40040.....	13	76591.....	70	AD3511C82.....	44
19228.....	38	30240RECY.....	8	30655.....	29	40120.....	12, 15	77002.....	70	AD3511CAST2.....	44
19320.....	38	30250.....	5	30656GY.....	29	40130.....	12, 15	77405.....	70	AD3511P.....	44
19416.....	38	30250RECY.....	8	30656GY240.....	29	40150.....	12	77410.....	70	AD3511P62.....	44
19715.....	38	30255.....	5	30656GY250.....	29	40170.....	12	77505.....	70	AD3511P82.....	44
19909.....	38	30260.....	5	30656GYASST.....	29	40210.....	5	77510.....	70	AD3511PAST2.....	44
20228.....	38	30265.....	5	30661.....	29	40220.....	5	77610.....	70	AD3517BSC.....	44
20320.....	38	30270.....	5	30676.....	29	40224.....	5	77710.....	70	AD3517BSP.....	44
20416.....	38	30280.....	7	30716BLACK.....	14	40228.....	38	77810.....	70	AD3517C.....	44
20701.....	40	30281.....	7	30718BLACK.....	14	40230.....	5	98325.....	39	AD3517C68.....	44
20702.....	40	30282.....	7	30776BLACK.....	14	40234.....	5	98400.....	32, 39	AD3517C88.....	44
20715.....	38	30283.....	7	30778BLACK.....	14	40239.....	5	98536.....	31	AD3517CAST.....	44
20902.....	38	30284.....	7	30796BLACK.....	14	40245.....	5	98600.....	29	AD3517CAST2.....	44
20909.....	38	30286.....	7	30812.....	32	40260.....	5	98600BEIGE.....	29	AD3517P.....	44
21280.....	7	30287.....	7	30900.....	58	40265.....	5	98636.....	29	AD3517P68.....	44
21281.....	7	30288.....	7	30902.....	58	40270.....	5	98536210SD.....	31	AD3517P88.....	44
21282.....	7	30289.....	7	30906.....	58	40280.....	7	98536210SS.....	31	AD3517PAST.....	44
21283.....	7	30290.....	7	30930.....	58	40281.....	7	98536220SD.....	31	AD3517PAST2.....	44
21284.....	7	30292.....	7	30936.....	58	40282.....	7	98536220SS.....	31	APRBENCH.....	33
21286.....	7	30293.....	7	31112.....	17, 59	40286.....	7	98536230SD.....	31	APRBENCH040.....	33
21287.....	7	30312.....	16	31118.....	17, 59	40287.....	7	98536230SS.....	31	APRBENCH090.....	33
21288.....	7	30318.....	16	31142.....	17, 59	40289.....	7	98536235SD.....	31	APRBENCH120.....	33
21289.....	7	30320.....	5	31148.....	17, 59	40290.....	7	98536235SS.....	31	APRBENCH150.....	33
29200.....	11, 12	30321.....	5	31162.....	17, 59	40292.....	7	98536320SD.....	31	APRBENCH312.....	33
29201.....	11, 12	30330RED.....	5	31164.....	17, 59	40312.....	16	98536320SS.....	31	APRD.....	33
29202.....	5, 11	30348BEIGE.....	8	31168.....	17, 59	40320.....	38	APRD18.....	33	APRD18AST00.....	35
29203.....	5, 11, 21	30358BEIGE.....	8	31182.....	17, 59	40321.....	5	AC3618.....	41	APRD18MOBILE.....	33
29300.....	11, 12	30400GRY10PK.....	14	31188.....	17, 59	40330.....	5	AC3618KD1ASY.....	42	APRD040.....	34
29301.....	5, 11, 13	30400WHI10PK.....	14	31620.....	25	403302PK.....	5	AC3618KD4AS.....	42	APRD080.....	34
29302.....	5, 11	30400YEL10PK.....	14	31625.....	25	40348.....	8	AC3618QV.....	41	APRD090.....	34
29303.....	5, 11	30420GRY6PK.....	14	31625RACK.....	25	40358.....	8	AC3618QV240.....	41	APRD110.....	34
29304.....	7, 11	30420WHI6PK.....	14	33011.....	21	40410.....	11	AC3618QV250.....	41	APRD112.....	34
30008.....	32	30424.....	32, 39	33023.....	21	40416.....	38	AC3618RT.....	42	APRD120.....	34
30016.....	32, 39	305A1.....	9	33061.....	21	40420.....	14	AC3618SHELF1PK.....	42	APRD130.....	34
30040.....	13	305A2.....	9	33105.....	21	40442.....	15	AC3618SV.....	41	APRD142.....	34
30048.....	13	305A3.....	9	33164.....	21	40462.....	15	AC3618SV240.....	41	APRD150.....	34
30080.....	13	305A4.....	9	33166.....	21	405A1.....	9	AC3618SV250.....	41	APRD162.....	34
30088.....	13	305A5.....	9	33168.....	21	405A3.....	9	AC3618Y.....	41	APRD170.....	34
30090.....	13	305A6.....	9	33220.....	21	405A5.....	9	AC3624.....	41	APRD182.....	34
30094.....	13	305B1.....	9	33223.....	21	405B1.....	9	AC3624Y.....	41	APRD312.....	35
30098.....	13	305B2.....	9	33224.....	21	40599.....	5	AC3624Y3AS.....	41	APRD18048.....	34
30101.....	12, 14	305B6.....	31	33226.....	21	40703.....	37	AC36243AS.....	41	APRD18088.....	35
30102.....	12, 14	30536A1.....	31	33228.....	21	40704.....	37	AC803618M26.....	41, 42	APRD18098.....	35
30110.....	12	30536A3.....	31	34240.....	24	40715.....	38	AC803624M26.....	41	APRD18118.....	35
30110RECY.....	14	30536A5.....	31	34301.....	24	40716.....	40	ACQV4C.....	43	APRD18128.....	35
30118.....	29	30536B1.....	31	34302.....	24	40717.....	40	ACQV4C2.....	43	APRD18138.....	35
30120.....	12	30536210S.....	31	34303.....	24	40901.....	38	ACQV4C62.....	43	APRD18158.....	35
30120RECY.....	14	30536220S.....	31	34304.....	24	40909.....	38	ACQV4C82.....	43	APRD18168.....	35
30124.....	12	30536230S.....	31	35010.....	19, 21	41105.....	21	ACQV4CAST.....	43	APRD18178.....	35
30124RECY.....	14	30536235S.....	31	35011.....	19, 21	41164.....	21	ACQV4P.....	43	APRD18188.....	35
30128.....	12	30536320S.....	31	35180.....	19	41166.....	21	ACQV4P42.....	43	APRD18318.....	35
30128RECY.....	14	30553.....	31	35181.....	19	41168.....	21	ACQV4P62.....	43	APRD1836448.....	35
30130.....	12	30553210S.....	31	35185.....	19	41220.....	21	ACQV4P82.....	43	APRD1836468.....	35
30130RECY.....	14	30553220S.....	31	35190.....	19	41223.....	21	ACQV4PAST.....	43	APRD36442B.....	34
30138.....	12	30553230S.....	31	35191.....	19	41224.....	21	ACS4C.....	43	APRD36462B.....	34
30138RECY.....	14	30553235S.....	31	35195.....	19	41226.....	21	ACS4C2.....	43	APRDAST.....	34
30148.....	32	30553A1.....	31	35200.....	19	41228.....	21	ACS4CAST.....	43	APRDAST00.....	34
30150.....	12	30553A3.....	31	35201.....	19	41230.....	5	ACS4C82.....	43	APRDMOBI.....	33
30150RECY.....	14	30553A5.....	31	35225.....	19	41250.....	5	ACS4P.....	43	APRS.....	33
30158.....	12	30553B1.....	31	35230.....	19	41270.....	5	ACS4P42.....	43	APRS18.....	33
30161.....	29	30553LF.....	31	35231.....	19	41284.....	7	ACS4P62.....	43	APRS18AST00.....	33
30164.....	12	30600BRACKET.....	25	35240.....	19	41286.....	7				
30164RECY.....	14	30600DOLLY.....	25	35241.....	19	41287.....	7				

# Product Index

MATERIAL HANDLING : STORAGE : TRANSPORT PRODUCTS

800.253.2467  
akro-mils.com

APRS040	34	AWS1836SHELF	46	R1B5HRX	61	R90262A1012	53	RPT2754	54
APRS080	34	AWS1836SINS	48	R1B5HRXL	61	R90262D3017	53	RPT3060	54
APRS090	34	AWS1848SAB	47	R1S5HR	60	R90262H20121017	53	RPT3672	54
APRS110	34	AWS1848SHELF	46	R1S5HR2LD	60	R90263A1011	53	RPT4010SP	69
APRS112	34	AWS2436SHELF	46	R1S8FP2	60	R90263A1012	53	RSSAKBINHDDOWN6	61
APRS120	34	AWS2448SHELF	46	R1S8MR	60	R90263D3017	53	RSSAKBINHDDOWN9	61
APRS130	34	AWS2460M30358	47	R1S8MR2	60	R90263H20121017	53	RSSAKBINHDDOWN12	61
APRS142	34	AWS2460M33224	48	R1S10FP2	60	R90263L20112017	53	RTOWHANDLE	64
APRS150	34	AWS2460M34240	47	R2ST5HR	60	R90281A1011	53	RUB43HR	66
APRS162	34	AWS2460SHELF	46	R2T5HR1830	61	R90281A1012	53	RUB43HR1420	22, 67
APRS170	34	AWS24360SAB	47	R2T5HR2436	61	R90281B2012	53	RUB43HR1422	19, 67
APRS182	34	AWS24360284	47	R2T5HR2448	61	R90281D3017	53	RUB43HR1519	67
APRS18048	35	AWS24360287	47	R2T8MR2448	61	R90281G10112017	53	RUB43HR1617	67
APRS18088	35	AWS24360288	47	R3ST5HR	60	R90281H20121017	53	RUB43HR1621	21
APRS18098	35	AWS24361288	47	R4ST5HR	60	R90281L20112017	53	RUB43HR1624	23, 67
APRS18118	35	AWS143630040	48	R4ST8MR	60	R90282A1011	53	RUB43HR1822	19, 67
APRS18128	35	AWS143630080	48	R5ST5HR	60	R90282A1012	53	RUB43HR1828	19, 67
APRS18138	35	AWS143630090	48	R5ST8MR	60	R90282B2012	53	RUB43HR2018	67
APRS18148	35	AWS143630120	47	R5SYT5HR2436	60	R90282D3017	53	RUB43HR2918	67
APRS18158	35	AWS143630130	47	R5SYT5HR3636	60	R90282G10112017	53	RUB43SS	66
APRS18168	35	AWS143630150	47	R5SYT8MR2436	60	R90282H20121017	53	RUB43TP1721	67
APRS18178	35	AWS143630170	47	R5SYT8MR3636	60	R90282L20112017	53	RUB43TP1727	67
APRS18188	35	AWS143630240	47	R214CS1841	61	R90284A1011	53	RUB43TP1821	67
APRS18318	35	AWS143630250	47	R214CS1859	61	R90284A1012	53	RUB43TP2122	67
APRS1836448	35	AWS143630312	48	R214CS1878	61	R90284B2012	53	RUB43TP2227	67
APRS1836468	35	AWS143630320	47	R214CS2841	61	R90284G10112017	53	RUB44HR	66
APRS312	34	AWS143636442B	48	R214CS2859	61	R90284L20112017	53	RUB44SS	66
APRS36442B	34	AWS143636462B	48	R214CS2878	61	R90285A1011	53	RUB53HR	66
APRS36462B	34	AWS183613014	48	R216CS2236	61	R90285A1012	53	RUB53SS	66
APRSAST	34	AWS183613018	48	R216CS2239	61	R219885MRB	55	RUB54HR	66
APRSAST00	34	AWS183630048	48	R216CS2836	61	R221812MRB	55	RUB54SS	66
AS1279	49	AWS183630088	48	R1130BRK	64	R2258516MRB	55	RWH2448EA5M6	57
AS1879	49	AWS183630098	48	R1151BRK	64	RA6TR4MR	24	RWH2448EA5M6A	57
AS1879ASORT	51	AWS183630128	47	R2108FPB	55	RA756MR	57	RWH3060EA5M6	57
AS2479	49	AWS183630138	47	R2125MRB	55	RA778MR	57	RWH3060EA5M6A	57
AS2479ASSORT	51	AWS183630158	47	R2168MRB	55	RACR5MR	24	RWH24481A5M8	56
AS3679	49	AWS183630178	47	R2178MRB	55	RCT40LW	68	RWH24481A5M8A	56
AS3679ASSORT	51	AWS183630265	47	R3008MR	68	RCTV40SP	66	RWH30601A5M8	56
AS187936	49	AWS183630270	47	R3010FP	68	RD843HR	68	RWH30601A5M8A	56
AS187942	49	AWS183630318	48	R3010SP	68	RD843SS	66	RWH2448EA5M6	57
AS1279040	50	AWS183630400	48	R4008MR	68	RD844HR	66	RWH2448EA5M6A	57
AS1279080	50	AWS183633166	48	R4008MR2	68	RD844SS	66	RWH3060EA5M6	57
AS1279090	50	AWS183633168	48	R4010FP	68	RD853HR	66	RWH3060EA5M6A	57
AS1279110	50	AWS183635180	48	R4010FP2	68	RD853SS	66	RWH24481A5M8	56
AS1279120	50	AWS183636448B	48	R4010SP	68	RD854HR	66	RWH24481A5M8A	56
AS1279130	50	AWS183636468B	48	R4010SP2	68	RD854SS	66	RWH24481A5Y6	56
AS1279150	50	AWS184813017	48	R4510SP	68	RD2416F3P	64	RWH24481A5Y6A	56
AS1279170	50	AWS184830260	47	R4510SP2	68	RD2416R3P	64	RWH30601A5M8	56
AS1279312	51	AWS184830280	47	R90110A1411	53	RD2416S3P	64	RWH24481A5M8A	56
AS1879048	50	AWS184830281	47	R90110A1412	53	RD2718F3P	64	RWH30601A5Y6	56
AS1879088	50	AWS184830282	47	R90110B2412	53	RD2718RC3P	64	RWH30601A5Y6A	56
AS1879098	50	AWS184830283	47	R90110G14112817	53	RD2718S3P	64	RWHV2448EA5M6	57
AS1879128	50	AWS243630094	48	R90110L24112817	53	RD3018AC3P	64	RWHV2448EA5M6A	57
AS1879138	50	AWS244830124	47	R90162A1411	53	RD3018CE3P	64	RWHV3060EA5M6	57
AS1879158	50	AWS244830164	47	R90162A1412	53	RD3018F3P	64	RWHV3060EA5M6A	57
AS1879178	50	AWS244830174	47	R90162D3817	53	RD3018R3P	64	RWHV24481A5M8	56
AS1879318	51	AWS244830184	47	R90162H24121817	53	RD3018RC3P	64	RWHV24481A5M8A	56
AS2479094	50	AWS244830420	48	R90163A1411	53	RD3018S3P	64	RWHV24481A5Y6	56
AS2479284	51	AWS244837608	47	R90163A1412	53	RD3624AC3P	64	RWHV24481A5Y6A	56
AS2479287	51	AWS246035225	48	R90163D3817	53	RD3624CE3P	64	RWHV30601A5M8	56
AS2479288	51			R90163H24121817	53	RD3624F3P	64	RWHV30601A5M8A	56
AS3679292	51			R90163L24112817	53	RD3624R3P	64	RWHV30601A5Y6	56
AS3679293	51			R90181A1411	53	RD3624S3P	64	RWHV30601A5Y6A	56
AS127936442B	51			R90181A1412	53	RD4824F3P	64		
AS127936462B	51			R90181B2412	53	RD4824S3P	64		
AS187913014	51			R90181D3817	53	RDT4008SP	69		
AS187913017	51			R90181G14112817	53	RDT4010FP	69		
AS187913018	51			R90181H24121817	53	RDT4010SP	69		
AS187936448B	51			R90181L24112817	53	RF718MR	57		
AS187936468B	51			R90182A1411	53	RGTD10FP	68		
ASC1279	49			R90182A1412	53	RGTD10SP	68		
ASC1279AST	50			R90182B2412	53	RGTS10FP	68		
ASC1279112	50			R90182D3817	53	RGTS10SP	68		
ASC1279142	50			R90182G14112817	53	RHDLHOOK	66		
ASC1279162	50			R90182H24121817	53	RHWB2448P5PYOG	62		
ASC1279182	50			R90182L24112817	53	RHWB3060	63		
ASC1879	49			R90184A1411	53	RHWB3072	63		
ASC1879118	50			R90184A1412	53	RM718MR	57		
ASC1879148	50			R90184B2412	53	RMD2ST5SR	62		
ASC1879168	50			R90184G14112817	53	RMD2ST5SR1830WE	62		
ASC1879188	50			R90184L24112817	53	RMD3ST5SR	62		
ASC1879AST	50			R90185A1411	53	RMD3018F4PN	65		
AWFOOTPLATE	46			R90185A1412	53	RMD3018F4RX	65		
AWP63CASTER	46			R90210A1011	53	RMD3018FN	65		
AWP63CASTNB	46			R90210A1012	53	RMD3018RC4PN	65		
AWP63UPRIGHT	46			R90210B2012	53	RMD3018RC4RX	65		
AWP74UPRIGHT	46			R90210G10112017	53	RMD3018RCN	65		
AWS1436SHELF	46			R90210L20112017	53	RMB24485SRTPG	62		
AWS1836M34301	47			R90262A1011	53	RPT2448	54		
		<b>H</b>						<b>T</b>	
		HD4824A	42					TV24F	37
		HD4824E	42					TV24R	37
		HD4824F	42					TV48F	37
								TV48R	37
		<b>L</b>						TV70F	37
		LVDMOBILE	29					TV70R	37
								TVCLIP	37
		<b>M</b>						TVHDWR	37
		MA3618C	59					TVLR	37
		MA3618C1	59					TVLRA	37
		MA3618CAST	59						
		MA3618P	59						
		MA3618P1	59						
		MA3618PAST	59						
		MA4824C	59						
		MA4824C1	59						
		MA4824C2	59						
		MA4824C3	59						
		MA4824P	59						
		MA4824P1	59						
		MA4824P2	59						
		MA4824P3	59						
				<b>R</b>					
		R1495	64						
		R1B5HR	61						
		R1B5HRL	61						



